



Additaments Compatibles

www.eliteabutments.com











Índex

Interfases i scanbodis Elite Abutments °	4
Rèpliques digitals i llibreries digitals Elite Abutments °	5
Transepitelials Multi-Use i Elitor°	6
Kit extractor d'implants i cargols coronats	7
Kits claus protètiques	8
Etiquetat i Certificacions	10

Llistat de compatibilitats

 Astra ° Evolution ° [Ø3.0 / Ø3.6 / Ø4.2 / Ø4.8 / Ø5.4]	12
 Astra ° Osseospeed ° [Ø3.0 / Ø3.5 -Ø4.0 / Ø4.5-Ø5.0]	14
 Biomet ° 3i° Certain ° [Ø3.4 / Ø4.10 / Ø5.0]	16
 Biomet ° 3i° Osseotite ° Ø3.4 / Ø4.1 / Ø5.1]	18
 Bti ° Interna ° [Ø4.1 / Ø5.5]	21
 Dentsply ° Ankylos ® C/X [Ø3.5 / Ø4.5 / Ø5.5]	23
 Megagen ° Anyridge ° [Ø3.5-Ø6.0]	24
 Mis ° Seven ° [Ø3.3 / Ø3.75 / Ø4.5]	25
 Neodent ° CM [Ø3.5 / Ø4.5 / Ø5.5]	27

	Neodent ° GM [Ø3.5]	28
	Nobel Biocare ° Brånemark System ° [Ø3.5 / Ø4.1 / Ø5.1]	29
	Nobel Biocare ° Nobel Active ° [Ø3.0 / Ø3.5 / Ø4.3]	32
	Nobel Replace ° Select [Ø3.5 / Ø4.3 / Ø5.0]	34
	Osstem Implant ° TS Implant [Ø4.0 / Ø4.5 / Ø5.5]	36
	Straumann ° Bone Level [Ø3.3 / Ø4.1]	37
	Straumann ° Tissue Level [Ø4.8 / Ø6.5]	39
	Componentes Sistema Synocta [Ø4.8]	41
	Sweden Y Martina ° Premium Kohno ° [Ø3.3 / Ø3.8 / Ø4.25]	42
	Zimmer ° Screw Vent ° [Ø2.9 / Ø3.5 / Ø4.5 / Ø5.7]	44
	Components Multi-Use° [Ø4.8 / Ø6.5]	46
	Components Sobredentadura Elitor°	47
	Claus i Eines	48
	Altres Connexions i Biomaterials	51

Interfases

Fabricades en titani grau 5, les interfases cimentables d'última generació Elite Abutments® garanteixen una **unió perfecta** entre implants i restauracions conferint una **major estabilitat i durabilitat** als treballs dentals,

El seu disseny amb finestra lateral permet corregir angulacions amb més facilitat i la cara plana permet una **perfecta orientació amb la connexió de l'implant**. L'acabat anoditzat garanteix els millors resultats estètics.

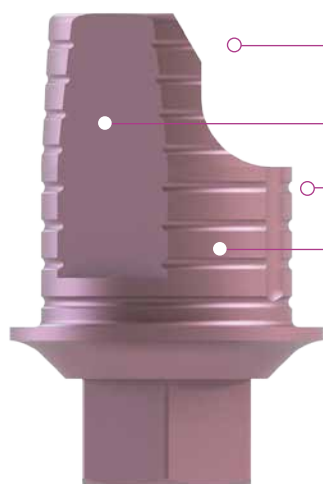

Finestra per a pròtesis angulades.

Cara Plana per a una orientació perfecta amb la connexió de l'implant.

Ranures per a una perfecta cimentació.

Anoditzat Pink® per a excel·lents resultats estètics.

Scanbody

Els nous scanbody estan **fabricats en Titani Grau 5 o Peek Radio Opac** una major durabilitat. El disseny amb doble cara permet una perfecta identificació de la posició de la connexió de l'implant i el seu tractament superficial garanteix una imatge perfecta als RX. El **gravat làser permet una fàcil identificació del producte** tant física com virtualment a les llibreries digitals Elite Abutments®.



Fabricat en Titani grau 5

Doble cara plana per a una fàcil identificació de la posició de la connexió

Radiopac per a una perfecta imatge en rx

Gravat làser per a una fàcil identificació del producte

Rèpliques Digitals

Descobriu les nostres noves rèpliques digitals, **una revolució en precisió i qualitat**. Fabricades en titani grau 5, garanteixen una durabilitat i resistència excepcionals. Cada rèplica compta amb marcat làser per a una fàcil identificació, assegurant una integració perfecta al teu flux de treball. Les rèpliques digitals **inclouen el cargol dissenyat específicament per a un ajustament òptim**.



Gravat làser per a una fàcil identificació del producte

Fabricat en Titani grau 5

Cargol inclòs

Llibreries Digitals

Trobeu tota la informació a la secció Cad-Cam que trobareu al menú superior del nostre lloc web www.eliteabutments.com



O escanegeu el següent codi QR



Guia d'instal·lació de les llibreries

- Pas 1:** Accediu a www.eliteabutments.com i feu clic a la secció CAD-CAM que trobareu al menú superior.
- Pas 2:** Feu clic a descarregar llibreries i ompliu el formulari.
- Pas 3:** Rebreu un enllaç de descàrrega al vostre correu electrònic. Aquest procés pot trigar uns minuts.
- Pas 4:** Instal·leu les llibreries de les connexions que necessiteu.



exocad

elite[®]
ABUTMENTS

Pilars Multi-Use

Descobriu la versatilitat dels nostres pilars Multi-Use: una àmplia gamma de transeptals per a totes les connexions, **disponibles en versions rectes i angulades de 17° i 30°**

Dissenyats per a la màxima precisió en la connexió de l'implant, aquests pilars **asseguren una adaptació i funcionalitat excepcionals**. Eleveu l'estàndard de les vostres restauracions dentals amb solucions que prometen durabilitat i una estètica superior.

Trobeu els components protètics a la pàgina 44, secció "Components Multi-Use"

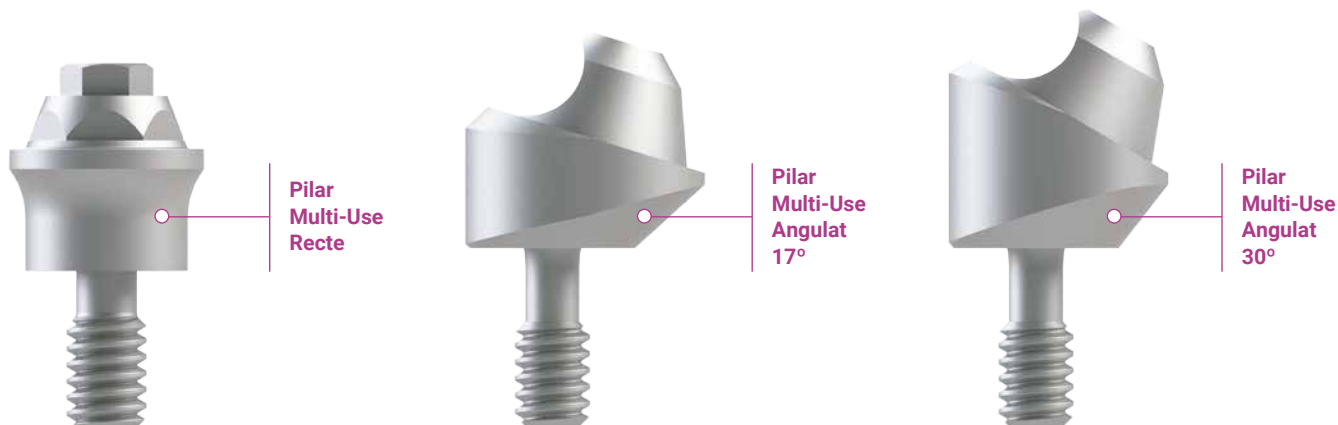

Pilars Elitor

Els pilars per a sobredentadura Elitor estan **fabricats en Titani grau 5 i amb recobrimient de TiN**, garantint resistència i biocompatibilitat excepcionals. Disponibles en un gran assortiment de alçades i plataformes, els pilars són **100% compatibles amb el sistema Locator** *

Els nostres Kits de Processament li **permeten corregir divergències entre implants de fins a 40°** i l'eina multifunció per als pilars Elitor us permetrà una fàcil gestió dels canvis de retenidors.

Tots els components per als pilars Elitor els trobareu a la pàgina 45, secció "Components de Sobredentadura Elitor"

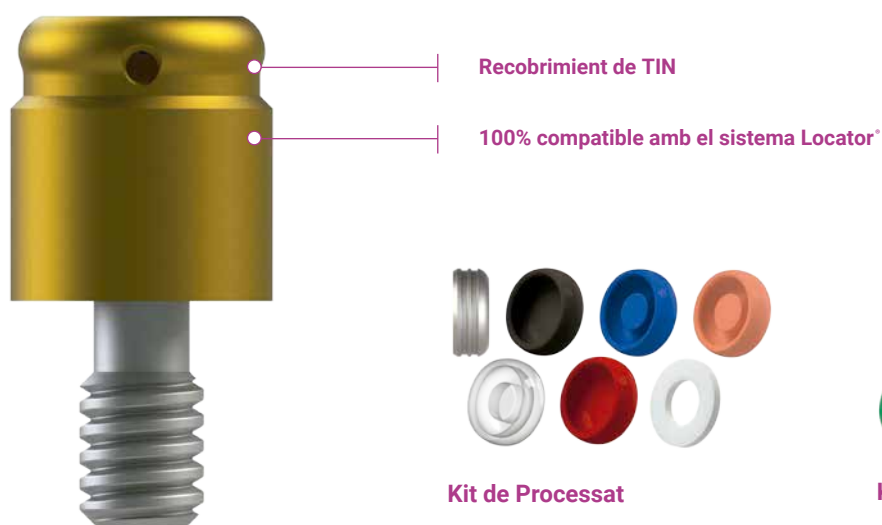

AU65-009KIT

AU65-009KITANG

Extractors d'Implants Dentals i Cargols Coronats



AU EXT-IMP KIT-2

Kit de Extractors No 1, 2, 3, 4 (inclou Adaptador + Extensor + Caixa)

El Kit Extractor d'Implants Dentals de **Elite Abutments**®, permet la **retirada de cargols coronats** amb la connexió de la clau deformada, així com la **extracció atraumàtica d'implants dentals**.

Components fabricats en **acer inoxidable**, emmagatzemats en estoig esterilitzable d'alumini.

Els extractors d'implants dentals es diferencien per un codi numèric a la part superior per facilitar així la seva identificació.



Extractor Cargol Coronat N.1 per Carraca Quadrada 4x4mm

Dissenyat per a la retirada de cargols amb la connexió coronada. Universal per a cargols **hexagonals de 1.20, 1.25, 1.27, 1.30, Unigrip, Torx.**

AU EXT-IMP-1



Extractor Cargol Coronat N.2 per Carraca Quadrada 4x4mm

Dissenyat para **la retirada de cargols amb la connexió totalment deteriorada**. S'utilitza quan l'extractor N°1 no subjecta o arrossega la zona afectada.

AU EXT-IMP-2



Extractor Cargol Coronat N.3 per Carraca Quadrada 4x4mm

Per implants dentals de rosca **M1.6** i Carraca Quadrada 4x4mm.

AU EXT-IMP-3



Extractor Cargol Coronat N.4 per Carraca Quadrada 4x4mm

Per implants dentals de rosca **M1.8 i M2.0** Carraca Quadrada 4x4mm.

AU EXT-IMP-4



Extensor per a Carraca Quadrada 4x4mm

S'utilitza juntament a l'adaptador de clau per al posicionament manual.

AU59-100195



Adaptador Clau Carraca Quadrada 4x4mm

S'utilitza juntament a l'extensor de carraca per el posicionament manual.

AU59-100191

Instruccions d' Ús

Pas 1

Introduir manualment el extractor recte i alineat amb l'implant i cargolar en el sentit contrari a les agulles del rellotge per posicionar.

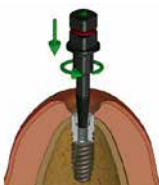

Pas 2

Acoblar la carraca a l'extractor, i enroscar cap a l'esquerra a sentit contrari a les agulles del rellotge.

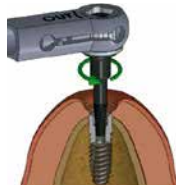

Pas 3

Quan l'extractor estigui ancorat a la rosca del implant dental, aquest s'anirà descargolant de forma progressiva.



Elements dels Kits de Claus de Contra-Angle

CLAUS DE MOTOR CONTRA-ANGLE

- Equilibrades en termes de funcionalitat i robustesa, amb una elevada resistència al desgast, la deformació i la corrosió.
- Fabricades amb acer inoxidable d'alt rendiment amb un tractament antidesgast de 55 HRC per allargar la vida útil de la clau.
- Acabat estètic en gris metal·litzat.

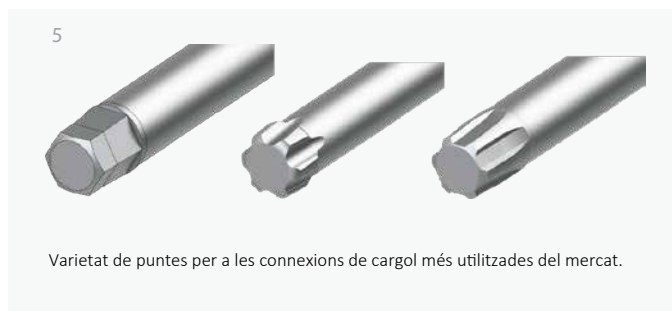

- 1** Puntes gravades per a la identificació ràpida de la seva funció.
- 2** Geometria per absorbir microdeformacions per torque i evitar clavats en contra-angle.
- 3** Toleràncies de mesura deumillesimal en la connexió per garantir la retenció.
- 4** Canya esvelta, resistent i amb longitud estudiada per a la seva perfecta inserció als canals interns de les pròtesis.
- 5** Combinació de zona recta i zona cònica a totes les cares per al millor equilibri entre retenció i resistència a la deformació.

ADAPTADOR MULTIFUNCIONAL PER ÚS DIRECTE A CARRACA O CLAU MANUAL



Inserció amb ajustament retentiu

- 1** Orifici per passar el fil de seguretat i evitar el desprendiment de la clau dins de la boca del pacient.
- 2** Corona giratòria estudiada per optimitzar l'ergonomia de treball.
- 3** Moletejat central bifuncional com a ajustament precís a carraca i per evitar lliscaments en l'ús manual.
- 4** Disponible en Ø 7 compatible STRAUMANN i Ø 8 compatible NOBEL BIOCARE.



Perfecta i ajustada adaptació al contra-angle, amb longitud mínima estudiada per a les claus curtes.



Perfecta i ajustada adaptació al contra-angle, amb longitud mínima estudiada per a les claus curtes.



Perfecta i ajustada adaptació al contra-angle, amb longitud mínima estudiada per a les claus curtes.

ENVÀS

- Inserció directa de les claus a l'adaptador des del propi envàs.
- Envàs esterilitzable amb autoclau i d'emmagatzematge òptim, tant de claus curtes com llargues.
- Gravats de la ubicació de cada clau per facilitar-ne la identificació ràpida.
- Envàs diferenciat per a claus curtes i llargues a través del color de la base.
- 2 ubicacions lliures per a col·locació de claus especials no incorporades al kit.



Claus curtes AU58-100001



Claus llargues AU58-100002

Detall color diferencial per a claus curtes (blau) i claus llargues (vermell).

Contingut del kit de claus contra-angle curtes

AU59-100198	Adaptador per clau de Contra-Angle a carraca de Ø 7.0 mm	
AU58-100205-S	Clau Per a Contra-Angle Curta HEX. 0.90	
AU58-100130	Clau Per a Contra-Angle Curta HEX. 1.20	
AU58-100120	Clau Per a Contra-Angle Curta HEX. 1.25	
AU58-100117	Clau Per a Contra-Angle Curta HEX. 1.27	
AU58-100185	Clau Per a Contra-Angle Curta HEX. 1.70	
AU58-100174	Clau Per a Contra-Angle Curta TORX	
AU58-100178	Clau Per a Contra-Angle Curta UNIGRIP	
AU58-100300	Clau Per a Contra-Angle Curta Angled Grip	
AU58-100160	Clau Motor Contra-Angle Multi-Unit Hex.2"	
AU58-100146	Clau Motor Contra-Angle Locator Curta	

Contingut del kit de claus contra-angle llargues

AU59-100198	Adaptador per clau de Contra-Angle a carraca de Ø 7.0 mm	
AU58-100205	Clau Per a Contra-Angle Llarga HEX. 0.90	
AU58-100111-M	Clau Per a Contra-Angle Llarga HEX. 1	
AU58-100135	Llave Para Contra-Ángulo Larga HEX. 1.20	
AU58-100125	Clau Per a Contra-Angle Llarga HEX. 1.25	
AU58-100118	Clau Per a Contra-Angle Llarga HEX. 1.27	
AU58-100186	Clau Per a Contra-Angle Llarga HEX. 1.70	
AU58-100174-M	Clau Per a Contra-Angle Llarga TORX	
AU58-100178-M	Clau Per a Contra-Angle Llarga UNIGRIP	
AU58-100133-M	Clau Per a Contra-Angle Llarga Quadrada 1.30	
AU58-100300-M	Clau Per a Contra-Angle Llarga Angled Grip	

Etiquetatge

Etiquetatge de productes normativa MDR 2017/745

1. Descripció de la connexió
2. Descripció del producte
3. Referència del producte
4. Número de lot
5. Símbol que indica que les instruccions d'ús contenen advertències.
6. Símbol que el producte està destinat a un sol ús.
7. Símbol que indica que el producte no es pot reesterilitzar.
8. Símbol "Consulteu Instruccions d'ús".
9. Símbol que identifica el producte com a no estèril.
10. Aquest símbol només s'aplica a models de productes que tenen cobalt en la composició (TCSC)
11. Marcat CE amb número d'organisme Notificat
12. Símbol que identifica el producte com a dispositiu mèdic.
13. Símbol "Mantenir allunyat de la llum solar"
14. Símbol "Mantenir sec".
15. Data de fabricació
16. Codi UDI d'identificació de producte sanitari.
(01) UDI-DI del producte
(10) Data de fabricació.
(11) Núm. de lot
17. Dades completes del fabricant.
18. Codi QR que dirigeix al lloc web on estan allotjades les Instruccions d'Ús.



Certificacions



ISO 9001:2015



ISO 13485:2016



Certificat CE

Catàleg General

CONNEXIONS COMPATIBLES





Astra[®] Evolution[®]

Plataformes:

Ø3.00 / Ø3.60 / Ø4.20 / Ø4.80 / Ø5.40

Connexió Cargol Clínic:



Hexagonal 1.27

Compatible amb:

Astra[®] Evolution[®]

Pilar Cicatrització Torque màx: 20 Ncm



	Ø3.60	Ø4.20	Ø4.80
Perfil Emergència	Ø4.50	Ø5.50	Ø6.50
			
H 2.0 mm	AU20-362120-45	AU20-422120-55	AU20-482120-65
H 4.0 mm	AU20-362140-45	AU20-422140-55	AU20-482140-65
H 6.0 mm	AU20-362160-45	AU20-422160-55	-

Coping Impressió



	Ø3.60	Ø4.20	Ø4.80
Cubeta Oberta	AU20-360090	AU20-420090	AU20-480090



Rèplica



	Ø3.00	Ø3.60	Ø4.20	Ø4.80	Ø5.40
	AU20-300015	AU20-360015	AU20-420015	AU20-480015	AU20-540015



Cargol Clínic Torque màx: 25 Ncm



	Ø3.00	Ø3.60	Ø4.20	Ø4.80 - Ø5.40
Hex. 1.27	M1.4	M1.6	M1.8	M2
Normal	AU20-300056	AU20-360056	AU20-420056	AU20-480056



Pilar Provisional



	Ø3.60	Ø4.20	Ø4.80
Antirrotatori	AU20-360300	AU20-420300	AU20-480300
Rotatori	AU20-360350	AU20-420350	AU20-480350



Veure eines a la pàgina 48

Cargol no inclòs a l'envàs

Calcinable amb Base Cr-Co



	Ø3.60	Ø4.20	Ø4.80
Antirrotatori	AU20-360400	AU20-420400	AU20-480400
Rotatori	AU20-360450	AU20-420450	AU20-480450



Calcinable (POM C)



	Ø3.00	Ø3.60	Ø4.20	Ø4.80	Ø5.40
Antirrotatori	AU20-300200	AU20-360200	AU20-420200	AU20-480200	AU20-540200
Rotatori	-	AU20-360250	AU20-420250	AU20-480250	AU20-540250



Cargol no inclòs a l'envàs

Cargol no inclòs a l'envàs

Pilar Multi-Use Recte Torque màx: 30 Ncm

	Ø3.60	Ø4.20	Ø4.80
H 1.5 mm	AU20-361015	AU20-421015	AU20-481015
H 2.5 mm	AU20-361025	AU20-421025	AU20-481025
H 3.5 mm	AU20-361035	AU20-421035	AU20-481035
H 4.5 mm	AU20-361045	AU20-421045	AU20-481045
H 5.5 mm	AU20-361055	AU20-421055	AU20-481055



Veure components Multi-Use a la pàgina 46

Pilar Multi-Use Angulat Torque màx: 30 Ncm

	Ø3.60	Ø4.20	Ø4.80	
17°	H 2.5 mm	AU20-361217-25	AU20-421217-25	AU20-481217-25
	H 3.5 mm	AU20-361217-35	AU20-421217-35	AU20-481217-35
30°	H 3.5 mm	AU20-361230-35	AU20-421230-35	AU20-481230-35
	H 4.5 mm	AU20-361230-45	AU20-421230-45	AU20-481230-45



Veure components Multi-Use a la pàgina 46

Pilar Elitor Recte Torque màx: 30 Ncm

	Ø3.60	Ø4.20	Ø4.80
H 1.0 mm	AU65-AEV361	AU65-AEV421	AU65-AEV481
H 2.0 mm	AU65-AEV362	AU65-AEV422	AU65-AEV482
H 3.0 mm	AU65-AEV363	AU65-AEV423	AU65-AEV483
H 4.0 mm	AU65-AEV364	AU65-AEV424	AU65-AEV484
H 5.0 mm	AU65-AEV365	AU65-AEV425	AU65-AEV485



Veure components Elitor a la pàgina 47



Astra® Osseospeed®

Plataformes:

Ø3.0 YELLOW / Ø3.5 / Ø4.0 AQUA / Ø4.5 / Ø5.0 LILAC

Connexió Cargol Clinic:

Hexagonal 1.27

Compatible amb:

Astrá Osseospeed

Pilar Cicatrització Torque màx: 20 Ncm



Perfil Emergencia	Ø3.0 Yellow	Ø3.5 / Ø4.0 Aqua		Ø4.5 / Ø5.0 Lilac	
	Ø3.6	Ø4.50	Ø5.50	Ø5.50	Ø5.65
H 2.0 mm	AU30-302120	AU30-352120-D45	AU30-352120-D55	AU30-452120-D55	AU30-452120-D65
H 4.0 mm	AU30-302140	AU30-352140-D45	AU30-352140-D55	AU30-452140-D55	AU30-452140-D65
H 6.0 mm	AU30-302160	AU30-352160-D45	AU30-352160-D55	AU30-452160-D55	AU30-452160-D65

Coping Impressió



	Ø3.0 Yellow	Ø3.5/Ø4.0 Aqua	Ø4.5/Ø5.0 Lilac
Cubeta Oberta	AU30-300090	AU30-350090	AU30-450090
Cubeta Tancada	-	-	-



Rèplica



	Ø3.0 Yellow	Ø3.5/Ø4.0 Aqua	Ø4.5/Ø5.0 Lilac
12 Posicions	AU30-300015	AU30-350015	AU30-450015
6 Posicions	-	AU30-350016	-



Cargol Clinic Torque màx:25 Ncm



	Ø3.0 Yellow	Ø3.5/Ø4.0 Aqua	Ø4.5/Ø5.0 Lilac
Hex. 1.27	M1.4	M1.6	M2
Normal	AU30-300052	AU30-350052	AU30-450052
DLC	-	AU30-350052-N	AU30-450052-N



Veure eines a la pàgina 48

Pilar Provisional



	Ø3.0 Yellow	Ø3.5/Ø4.0 Aqua	Ø4.5/Ø5.0 Lilac
Antirrotatori	-	AU30-350300	AU30-450300
Rotatori	-	AU30-350350	AU30-450350



Cargol no inclòs a l'envàs

Calcinable amb Base Cr-Co



	Ø3.0 Yellow	Ø3.5/Ø4.0 Aqua	Ø4.5/Ø5.0 Lilac
Antirrotatori	-	AU30-350400	AU30-450400
Rotatori	-	AU30-350450	AU30-450450



Cargol no inclòs a l'envàs

Calcinable (POM C)



	Ø3.0 Yellow	Ø3.5/Ø4.0 Aqua	Ø4.5/Ø5.0 Lilac
Antirrotatori	AU30-300200	AU30-350200	AU30-450200
Rotatori	-	AU30-350250	AU30-450250



Cargol no inclòs a l'envàs

Pilar Cimentable Recte



		Ø3.5/Ø4.0 Aqua	Ø4.5/Ø5.0 Lilac
Antirrotatori	H 0.0 mm	AU30-351320	-
	H 1.0 mm	AU30-351321	-
	H 2.0 mm	-	AU30-451320
	H 3.0 mm	AU30-351323	-
	H 4.0 mm	AU30-351325	-
Rotatori	H 0.0 mm	AU30-351330	-



Cargol no inclòs a l'envàs

Pilar Elitor Recte Torque màx: 30 Ncm



	Ø3.0 Yellow	Ø3.5/Ø4.0 Aqua	Ø4.5/Ø5.0 Lilac
H 1.0 mm	-	AU65-AS351	AU65-AS451
H 2.0 mm	-	AU65-AS352	AU65-AS452
H 3.0 mm	-	AU65-AS353	AU65-AS453
H 4.0 mm	-	AU65-AS354	AU65-AS454
H 5.0 mm	-	AU65-AS355	AU65-AS455
H 6.0 mm	-	AU65-AS356	AU65-AS456



Veure components Elitor a la pàgina 47

Pilar Multi-Use Recte Torque màx: 30 Ncm



	Ø3.0 Yellow	Ø3.5/Ø4.0 Aqua	Ø4.5/Ø5.0 Lilac
H 1.5 mm	-	AU30-351015	AU30-451015
H 2.5 mm	-	AU30-351025	AU30-451025
H 3.5 mm	-	AU30-351035	AU30-451035
H 4.5 mm	-	AU30-351045	AU30-451045



Veure components Multi-Use a la pàgina 46

Pilar Multi-Use Angulat Torque màx: 30 Ncm



		Ø3.5/Ø4.0 Aqua	Ø4.5/Ø5.0 Lilac
17°	H 2.5 mm	AU30-351217	AU30-451217
	H 3.5 mm	AU30-351217-35	AU30-451217-35
	H 4.0 mm	-	-
30°	H 3.5 mm	AU30-351230-35	AU30-451230
	H 4.5 mm	AU30-351230-45	AU30-451230-45
	H 6.0 mm	-	-



Veure components Multi-Use a la pàgina 46

Cargol Clínic Angulable Torque màx: 25 Ncm



	Ø3.0 Yellow	Ø3.5/Ø4.0 Aqua	Ø4.5/Ø5.0 Lilac
Connexió		M1.6	M2
Tetralobular	-	AU30-350050	AU30-450050
Angled Grip*	-	AU30-350060	AU30-450060



Veure eines a la pàgina 48

Scanbody



	Ø3.0 Yellow	Ø3.5/Ø4.0 Aqua	Ø4.5/Ø5.0 Lilac
-		AU30-352201	AU30-452201

Cargol no inclòs a l'envàs



Rèplica Digital



	Ø3.0 Yellow	Ø3.5/Ø4.0 Aqua	Ø4.5/Ø5.0 Lilac
-		AU30-350010	AU30-450010



Base Cr-Co Angulable



	Ø3.0 Yellow	Ø3.5/Ø4.0 Aqua	Ø4.5/Ø5.0 Lilac
Antirrotatori	-	AU30-350410	AU30-450410
Rotatori	-	AU30-350460	AU30-450460



Cargol no inclòs a l'envàs

Xemeneia Calcinable Angulada



	Ø3.5/Ø4.0 Aqua	Ø4.5/Ø5.0 Lilac
17°	AU67-001701	AU67-001701
30°	AU67-003001	AU67-003001



Interfases Angulables



		Ø3.5/Ø4.0 Aqua	Ø4.5/Ø5.0 Lilac
Antirrotatori	H 1.5 mm	AU30-350600-15	AU30-450600-15
Rotatori	H 1.5 mm	AU30-350650-15	AU30-450600-15



Cargol no inclòs a l'envàs



Biomet® 3i® Certain®

Plataforma:

NP Ø3.40 / RP Ø4.10 / WP Ø5.00

Connexió Cargol Clínic:

Hexagonal 1.20

Compatible amb:

Biomet 3i® Certain® y otros.

Pilar Cicatrització Torque màx: 20 Ncm



	RP Ø4.10
Perfil Emergència	Ø5.00



H 2.0 mm	AU14-412120-D50
H 3.0 mm	AU14-412130-D50
H 4.0 mm	AU14-412140-D50
H 6.0 mm	AU14-412160-D50

Rèplica



NP Ø3.40	RP Ø4.10	WP Ø5.00
AU14-340015	AU14-410015	AU14-500015



Coping Impressió



	NP Ø3.40	RP Ø4.10	WP Ø5.00
Cubeta Oberta	AU14-340090	AU14-410090	AU14-500090



Cargol Clínic Torque màx: 25 Ncm



		NP Ø3.40	RP Ø4.10	WP Ø5.00
	Hex. 1.20	M1.6	M1.6	M1.6
Additaments	Normal	AU14-340052	AU14-410052	AU14-410052
Rotatoris	DLC	AU14-340052-N	AU14-410052-N	AU14-410052-N
Additaments	Normal	AU14-340052	AU14-340052	AU14-340052
Antirrotatoris	DLC	AU14-340052-N	AU14-340052-N	AU14-340052-N



Pilar Provisional Torque màx: 30 Ncm



	NP Ø3.40	RP Ø4.10	WP Ø5.00
Antirrotatori	AU14-340300	AU14-410300	AU14-500300
Rotatori	AU14-340350	AU14-410350	AU14-500350



Cargol no inclòs a l'envàs

Veure eines a la pàgina 48

Calcinable amb Base Cr-Co



	Ø3.40	Ø4.10	Ø5.00
Antirrotatori	AU14-340400	AU14-410400	AU14-500400
Rotatori	AU14-340450	AU14-410450	AU14-500450



Cargol no inclòs a l'envàs

Calcinable (POM C)



	Ø3.40	Ø4.10	Ø5.00
Antirrotatori	AU14-340200	AU14-410200	AU14-500200
Rotatori	AU14-340250	AU14-410250	AU14-500250



Cargol no inclòs a l'envàs

Pilar Multi-Use Recte Torque màx: 30 Ncm



	NP Ø3.40	RP Ø4.10	WP Ø5.00
H 1.0 mm	AU14-341010	AU14-411010	AU14-501010
H 2.0 mm	AU14-341020	AU14-411020	AU14-501020
H 3.0 mm	AU14-341030	AU14-411030	AU14-501030
H 4.0 mm	AU14-341040	AU14-411040	AU14-501040



Veure components Multi-Use a la pàgina 46

Pilar Multi-Use Angulat Torque màx: 30 Ncm



	NP Ø3.40	RP Ø4.10	WP Ø5.00	
17°	H 2.0 mm	AU14-341217-2	AU14-411217-2	AU14-501217-2
	H 4.0 mm	AU14-341217-4	AU14-411217-4	AU14-501217-4
30°	H 3.0 mm	AU14-341230-3	AU14-411230-3	AU14-501230-3
	H 5.0 mm	AU14-341230-5	AU14-411230-5	AU14-501230-5



Veure components Multi-Use a la pàgina 46

Pilar Elitor Recte Torque màx: 30 Ncm



	NP Ø3.40	RP Ø4.10
H 1.0 mm	AU65-00CE341	AU65-00CE401
H 2.0 mm	AU65-00CE342	AU65-00CE402
H 3.0 mm	AU65-00CE343	AU65-00CE403
H 4.0 mm	AU65-00CE344	AU65-00CE404
H 5.0 mm	AU65-00CE345	AU65-00CE405
H 6.0 mm	AU65-00CE346	AU65-00CE406



Cargol Clínic Angulable Torque màx: 25 Ncm



	NP Ø3.40	RP Ø4.10	WP Ø5.00
Conexión	M1.6	M1.6	M1.6
Tetralobular	AU14-340050	AU14-340050	AU14-340050



Veure eines a la pàgina 48

Xemeneia Calcinable Angulada



	NP Ø3.40	RP Ø4.10	WP Ø5.00
17°	AU67-001701	AU67-001701	-
30°	AU67-003001	AU67-003001	-



Base Cr-Co Angulable



	NP Ø3.40	RP Ø4.10	WP Ø5.00
Antirrotatori	AU14-340410	AU14-410410	AU14-500410
Rotatori	AU14-340460	AU14-410460	AU14-500460



Cargol no inclòs a l'envàs

Interfases Angulables



	NP Ø3.40	RP Ø4.10	WP Ø5.00	
Antirrotatori	H 0.5 mm	AU14-340600-05	AU14-410600-05	AU14-500600-05
Rotatori	H 0.5 mm	AU14-340650-05	AU14-410650-05	AU14-500650-05



Cargol no inclòs a l'envàs

Scanbody



	NP Ø3.40	RP Ø4.10	WP Ø5.00
	AU14-342201	AU14-412201	AU14-502201



Cargol no inclòs a l'envàs

Rèplica Digital



NP Ø3.40	RP Ø4.10	WP Ø5.00
AU14-340010	AU14-410010	AU14-500010





Biomet® 3i® Osseotite®

Plataformes:

RP Ø4.1 / WP Ø5.1

Connexió Cargol Clinic:



Unigrip® / Hexagonal 1.20 / Hexagonal 1.25 / Cuadrada 1.30

Compatible amb:

Biomet 3i Osseotite Tapered

Pilar Cicatrització Torque màx: 20 Ncm



Perfil Emergencia	RP Ø4.10		WP Ø5.10
	Ø4.10	Ø5.50	Ø6.0
H 2.0 mm	 AU44-002120	 AU44-002120-50	-
H 3.0 mm	AU44-002130	AU44-002130-50	AU51-502130
H 4.0 mm	AU44-002140	AU44-002140-50	-
H 5.0 mm	AU44-002150	AU44-002150-50	AU51-502150

Coping Impressió



Rèplica



	RP Ø4.10	WP Ø5.10
Cubeta Abierta	AU44-000090	AU51-500090
Cubeta Cerrada	AU44-000080	-



	RP Ø4.10	WP Ø5.10
	AU44-000015	AU51-500015



Cargol Clinic

Torque màx: 25 Ncm



	RP Ø4.10	WP Ø5.10
Unigrip	M2	M2
Normal	AU44-E00057	AU44-E00057
DLC	AU44-E00057-N	AU44-E00057-N
Hexagonal 1.20	M2	M2
Normal	AU44-E00054	AU44-E00054
DLC	AU44-E00054-N	AU44-E00054-N

	RP Ø4.10	WP Ø5.10
Hexagonal 1.25	M2	M2
Normal	AU44-E00052	AU44-E00052
DLC	AU44-E00052-N	AU44-E00052-N
Quadrat 1.30	M2	M2
Normal	AU44-E00053	AU44-E00053
DLC	AU44-E00053-N	AU44-E00053-N



Veure eines a la pàg. 48

Calcinable amb Base Cr-Co



	RP Ø4.10	WP Ø5.10
Antirrotatori	AU44-000400	AU51-500400
Rotatori	AU44-000450	AU51-500450



Tornillo no inclòid en el envàs

Calcinable (POM C)



	RP Ø4.10	WP Ø5.10
Antirrotatori	AU44-E00200	AU51-500200
Rotatori	AU44-E00250	AU51-500250



Cargol no inclòid a l'envàs

Pilar Provisional



	RP Ø4.10	WP Ø5.10
TITANI	Antirrotatori	AU44-000300 AU51-500300
	Rotatori	AU44-000350 AU51-500350



Cargol no inclòid a l'envàs

	RP Ø4.10	WP Ø5.10
PEEK	Antirrotatori	AU44-000500 -
	Rotatori	AU44-000550 -



Cargol no inclòid a l'envàs

Pilar Cimentable Recte



	RP Ø4.10	WP Ø5.10
Antirrotatori	AU44-001320	-
Rotatori	AU44-001330	-



Cargol no inclòid a l'envàs

Pilar Cimentable Angulat



	RP Ø4.10	WP Ø5.10
15°	H 1.5 mm AU44-001515-15	-
25°	H 2.5 mm AU44-001525-2	-



Cargol no inclòid a l'envàs

Pilar Multi-Use Recte

Torque màx: 30 Ncm



	RP Ø4.10	WP Ø5.10
H 0.0 mm	-	-
H 1.0 mm	AU43-501010-CA	-
H 2.0 mm	AU43-501020-CA	-
H 3.0 mm	AU43-501030-CA	-
H 4.0 mm	AU43-501040-CA	-
H 5.0 mm	AU43-501050-CA	-
H 6.0 mm	-	-



Vegeu components Multi-Use a la pàgina 46

Pilar Multi-Use Angulat

Torque màx: 30 Ncm



	RP Ø4.10
17°	H 2.0 mm AU43-501217-2
	H 3.0 mm AU43-501217-3
	H 4.0 mm AU43-501217-4
30°	H 3.0 mm AU43-501230-3
	H 4.0 mm AU43-501230-4
	H 5.0 mm AU43-501230-5



Vegeu components Multi-Use a la pàgina 46

Pilar Elitor Recte

Torque màx: 30 Ncm



	RP Ø4.10	WP Ø5.10
H 0.0 mm	-	-
H 1.0 mm	AU65-00B401	-
H 2.0 mm	AU65-00B402	-
H 3.0 mm	AU65-00B403	-
H 4.0 mm	AU65-00B404	-
H 5.0 mm	AU65-00B405	-
H 6.0 mm	AU65-00B406	-



Vegeu components Elitor a la pàgina 46

Pilar Elitor Angulat

Torque màx: 30 Ncm



	RP Ø4.10
15°	H 1.5 mm AU65-B401A1515
	H 3.0 mm AU65-B401A1530



Vegeu components Elitor a la pàgina 46

Cargol Clínic Angulable

Torque màx: 25 Ncm



	RP Ø4.10	WP Ø5.10
Conexión	M2	
Tetralobular	AU44-E00050	-
Angled Grip*	AU44-E00060	-



Base Cr-Co Angulable



	RP Ø4.10	WP Ø5.10
Antirrotatori	AU44-000410	-
Rotatori	AU44-000460	-



Xemeneia Calcinable Angulada



RP Ø4.10 **WP Ø5.10**

AU67-001701 -



RP Ø4.10 **WP Ø5.10**

AU67-003001 -



Interfase Angulable



	RP Ø4.10	
Antirrotatori	H 0.5 mm	-
	H 1.5 mm	AU44-000600-15
	H 2.5 mm	AU44-000600-25
	H 3.5 mm	AU44-000600-35
Rotatori	H 0.5 mm	-
	H 1.5 mm	AU44-000650-15
	H 2.5 mm	AU44-000650-25
	H 3.5 mm	AU44-000650-35



Cargol no inclòs a l'envàs

Scanbody



RP Ø4.10 **WP Ø5.10**

AU44-412201 -

Cargol no inclòs a l'envàs



Rèplica Digital



RP Ø4.10 **WP Ø5.10**

AU44-000010 -



Sistema Transepitelial Estheticone

Pilar Estheticone Recte



	RP Ø4.10	WP Ø5.10
H 1.0 mm	AU43-201010	-
H 2.0 mm	AU43-201020	-
H 3.0 mm	AU43-201030	-

Veure components Elitor a la pàgina 47



Components Estheticone

	RP Ø4.10	WP Ø5.10
Tap de Cicatrizació Titani	CE 0051 AU43-200004	-
Rèplica	CE AU43-200015	-
Calcinable (POM-C) Antirrotatori	CE AU43-200200	-
Coping Impressió Cubeta Oberta	CE AU43-200090	-
Provisional Antirrotatori	CE 0051 AU43-200300	-

Cargol Clínic Estheticone

Torque màx:25 Ncm



	RP Ø4.10	WP Ø5.10
Unigrip	M1.4	
Normal	AU43-E50057	-
DLC	AU43-E50057-N	-

Veure eines a la pàgina 48

	RP Ø4.10	WP Ø5.10
Hexagonal 1.27	M1.4	
Normal	AU43-E50056	-
DLC	AU43-500056-N	-

Veure eines a la pàgina 48





BTI[®] Interna[®]

Plataformes:
RP Ø4.10 / WP Ø5.50

Connexió Cargol Clínic:
Hexagonal 1.20 / Cuadrada 1.30

Compatible amb:
BTf Interna

Pilar Cicatrització Torque màx: 20 Ncm



Perfil Emergència	RP Ø4.10
H 2.0 mm	AU22-412120
H 3.0 mm	AU22-412130
H 4.0 mm	AU22-412140
H 5.0 mm	AU22-412150
H 6.0 mm	AU22-412160
H 8.0 mm	AU22-412180

Coping Impressió



	RP Ø4.10	WP Ø5.50
Cubeta Oberta	AU22-410090	AU22-550090



Rèplica



Ø4.10	Ø5.50
AU22-410015	AU22-550015



Tornillo Clínic Torque màx:25 Ncm



	RP Ø4.10	WP Ø5.50
Hex. 1.20	M1.8	M1.8
Normal	AU22-000054	AU22-000054
DLC	AU22-000054-N	AU22-000054-N



	RP Ø4.10	WP Ø5.50
Cuadrada 1.30	M1.8	M1.8
Normal	AU22-000053	AU22-000053
DLC	AU22-000053-N	AU22-000053-N



Veure eines a la pàgina 48

Veure eines a la pàgina 48

Calcinable (POM C)



	RP Ø4.10	WP Ø5.50
Antirrotatori	AU22-410200	AU22-550200
Rotatori	AU22-410250	AU22-550250



Cargol no inclòs a l'envàs

Calcinable amb Base Cr-Co



	RP Ø4.10	WP Ø5.50
Antirrotatori	AU22-410400	AU22-550400
Rotatori	AU22-410450	AU22-550450



Cargol no inclòs a l'envàs

Pilar Multi-Use Recte Torque màx: 30 Ncm

	RP Ø4.10	WP Ø5.50
H 0.5 mm	AU22-411005	-
H 1.0 mm	AU22-411010	AU22-551010
H 2.0 mm	AU22-411020	AU22-551020
H 3.0 mm	AU22-411030	AU22-551030
H 4.0 mm	AU22-411040	AU22-551040
H 5.0 mm	AU22-411050	-



Veure components Multi-Use a la pàgina 46

Pilar Multi-Use Angulat Torque màx: 30 Ncm

	RP Ø4.10	WP Ø5.50
17°	H 2.0 mm	AU22-411217-2 -
	H 3.0 mm	AU22-411217-3 -
	H 4.0 mm	AU22-411217-4 -
30°	H 3.0 mm	AU22-411230-3 -
	H 4.0 mm	AU22-411230-4 -
	H 5.0 mm	AU22-411230-5 -



Veure components Multi-Use a la pàgina 46

Pilar Elitor Recte Torque màx: 30 Ncm

	RP Ø4.10	WP Ø5.50
H 1.0 mm	AU65-BT411	-
H 2.0 mm	AU65-BT412	-
H 3.0 mm	AU65-BT413	-
H 4.0 mm	AU65-BT414	-
H 5.0 mm	AU65-BT415	-
H 6.0 mm	AU65-BT416	-



Veure components Elitor a la pàgina 47

Pilar Provisional

	RP Ø4.10	WP Ø5.50
Antirotatori	AU22-410300	AU22-550300
Rotatori	AU22-410350	AU22-550350



Cargol no inclòs a l'envàs

Tornillo Clínico Multi-IM Torque màx:25 Ncm

	RP Ø4.10
Hex. 1.20	M1.4
NORMAL	AU22-000900



Veure eines a la pàgina 48



Dentsply Ankylos®

Plataforma:
Ø3.50 / Ø4.50 / Ø5.50 (UNIVERSAL)

Connexió Cargol Clínic:
Hexagonal 0.90

Compatible amb:
Ankylos® C/X

Pilar Cicatrització Torque màx: 20 Ncm



	Ø3.50	
Perfil Emergència	Ø3.50	Ø4.50



H 2.0 mm	AU27-352120-D35	AU27-352120-D45
H 3.5 mm	AU27-352135-D35	AU27-352135-D45
H 5.0mm	AU27-352150-D35	AU27-352150-D45

Coping Impressió



UNIVERSAL	
Cubeta Oberta	AU27-350090



Rèplica



UNIVERSAL	
	AU27-350015



Cargol Clínic Rotatori Escanejat

Torque màx: 25 Ncm



UNIVERSAL	
Hexagonal 0.90	M1.8
Normal	AU27-350051



Veure eines a la pàgina 48

Calcinable (POM C)



	Ø3.50
Rotatori	AU28-350250



Cargol no inclòs a l'envàs

Pilar Provisional Torque màx: 25 Ncm



UNIVERSAL	
Antirrotatori	AU27-350300
Rotatori	AU27-350350



Cargol no inclòs a l'envàs

Pilar Multi-Use Recte Torque màx: 30 Ncm



UNIVERSAL	
H 1.5 mm	AU28-351015
H 2.5 mm	AU28-351025
H 3.5 mm	AU28-351035
H 4.5 mm	AU28-351045
H 5.5 mm	AU28-351055



Veure components Multi-Use a la pàgina 46

Pilar Elitor Recte Torque màx: 30 Ncm



UNIVERSAL	
H 2.0 mm	AU65-NCM352
H 3.0 mm	AU65-NCM353
H 4.0 mm	AU65-NCM354
H 5.0 mm	AU65-NCM355
H 6.0 mm	AU65-NCM356



Veure components Elitor a la pàgina 47



Megagen[®] Anyridge[®]

Plataforma Universal:

Ø3.50 / Ø4.00 / Ø4.50 / Ø5.00 / Ø5.50 / Ø6.00

Connexió Cargol Clínic:

Hexagonal 1.20

Compatible amb:

Megagen[®] Anyridge[®]

Pilar Cicatrització Torque màx: 20 Ncm



	UNIVERSAL	UNIVERSAL
Perfil Emergència	Ø5.50	Ø6.50
H 2.0 mm	AU37-352120-55	AU37-352120-65
H 4.0 mm	AU37-352140-55	AU37-352140-65
H 6.0 mm	AU37-352160-55	AU37-352160-65

Coping Impressió



	UNIVERSAL
Cubeta Oberta	AU37-350090



Rèplica



UNIVERSAL
AU37-350015



Cargol Clínic Torque màx: 25 Ncm



	UNIVERSAL
Hexagonal 1.20	M1.8
Normal	AU37-350054



Veure eines a la pàgina 48

Calcinable amb Base Cr-Co



	UNIVERSAL
Antirrotatori	AU37-350400
Rotatori	AU37-350450



Cargol no inclòs a l'envàs

Calcinable (POM C)



	UNIVERSAL
Antirrotatori	AU37-350200
Rotatori	AU37-350250



Cargol no inclòs a l'envàs

Pilar Provisional



	UNIVERSAL
Antirrotatori	AU37-350300
Rotatori	AU37-350350



Cargol no inclòs a l'envàs

Pilar Multi-Use Recte Torque màx: 30 Ncm



	UNIVERSAL
H 1.5 mm	AU37-351015
H 2.5 mm	AU37-351025
H 3.5 mm	AU37-351035
H 4.5 mm	AU37-351045
H 5.5 mm	AU37-351055



Veure components Multi-Use a la pàgina 46

Pilar Elitor Recte Torque màx: 30 Ncm



	UNIVERSAL
H 1.0 mm	AU65-MA351
H 2.0 mm	AU65-MA352
H 3.0 mm	AU65-MA353
H 4.0 mm	AU65-MA354
H 5.0 mm	AU65-MA355
H 6.0 mm	AU65-MA356



Veure components Elitor a la pàgina 47



Mis[®] Seven[®]

Plataformes:

Narrow Ø3.30 / Standard Ø3.75 / Wide Ø4.50

Connexió Cargol Clinic:

Hexagonal 1.27

Compatible amb:

Mis Seven / Mis M4.

Pilar Cicatrització Torque màx: 20 Ncm



Perfil Emergència	Narrow Ø3.30	Standard Ø3.75				Wide Ø4.50	
		Ø3.50	Ø4.50	Ø4.80	Ø5.50	Ø4.50	Ø5.50
H 2.0 mm	AU26-332120	AU49-302120	AU49-302120-D45	-	AU49-302120-D55	-	-
H 3.0 mm	AU26-332130	AU49-302130	AU49-302130-D45	AU49-302130-D48	AU49-302130-D55	AU49-402130	AU49-402130-D55
H 4.0 mm	AU26-332140	AU49-302140	AU49-302140-D45	-	-	AU49-402140	AU49-402140-D55
H 5.0 mm	AU26-332150	AU49-302150	AU49-302150-D45	AU49-302150-D48	AU49-302150-D55	AU49-402150	AU49-402150-D55
H 6.0 mm	AU26-332160	-	-	-	-	-	-
H 7.0 mm	-	AU49-302170	AU49-302170-D45	AU49-302170-D48	AU49-302170-D55	-	-

Coping Impressió



	Narrow Ø3.30	Standard Ø3.75	Wide Ø4.50
Cubeta Oberta	AU26-330090	AU49-300090	AU49-400090
Cubeta Tancada	-	AU49-300080	-



Rèplica



	Narrow Ø3.30	Standard Ø3.75	Wide Ø4.50
	AU26-330015	AU49-300015	AU49-400015



Cargol Clínic

Torque màx: 25 Ncm



	Narrow Ø3.30	Standard Ø3.75	Wide Ø4.50
Hex. 1.27	M1.6	1-72 UNF (Ø 1.8MM)	
Normal	AU26-000056	AU49-E30056	AU49-E30056
DLC	Lorçm ipsum	AU49-E30056-N	AU49-E30056-N



Veure eines a la pàgina 48

Pilar Provisional



	Narrow Ø3.30	Standard Ø3.75	Wide Ø4.50
Antirrotatori	AU26-330300	AU49-300300	AU49-400300
Rotatori	AU26-330350	AU49-300350	AU49-400350



Cargol no inclòs a l'envàs

Calcinable amb Base Cr-Co



	Narrow Ø3.30	Standard Ø3.75	Wide Ø4.50
Antirrotatori	AU26-330400	AU49-300400	AU49-400400
Rotatori	AU26-330450	AU49-300450	AU49-400450



Cargol no inclòs a l'envàs

Calcinable (POM C)



	Narrow Ø3.30	Standard Ø3.75	Wide Ø4.50
Antirrotatorio	AU26-330200	AU49-300200-A	AU49-400200
Rotatorio	AU26-330250	AU49-300250-A	AU49-400250



Cargol no inclòs a l'envàs

Pilar Cimentable Recte Antirrotatori



	Narrow Ø3.30	Standard Ø3.75	Wide Ø4.50
H 0.0 mm	-	AU49-301320	AU49-401320
H 1.0 mm	-	AU49-301321	AU49-401321
H 2.0 mm	-	AU49-301322	AU49-401322
H 3.0 mm	-	AU49-301323	AU49-401323



Cargol no inclòs a l'envàs

Pilar Cimentable Angulat Antirrotatori



	Narrow Ø3.30	Standard Ø3.75	Wide Ø4.50
15°	H 1.0 mm	-	AU49-301515-1
	H 2.0 mm	-	AU49-301515-2
	H 3.0 mm	-	AU49-301515-3
25°	H 1.0 mm	-	AU49-301525-1
	H 2.0 mm	-	AU49-301525-2
	H 3.0 mm	-	AU49-301525-3



Cargol no inclòs a l'envàs

Pilar Multi-Use Recte Torque màx: 30 Ncm



	Narrow Ø3.30	Standard Ø3.75	Wide Ø4.50
H 1.0 mm	AU26-331010	AU49-301010	AU49-401010
H 2.0 mm	AU26-331020	AU49-301020	AU49-401020
H 3.0 mm	AU26-331030	AU49-301030	AU49-401030
H 4.0 mm	AU26-331040	AU49-301040	AU49-401040
H 5.0 mm	-	AU49-301050	AU49-401050



Veure components Multi-Use a la pàgina 46

Pilar Multi-Use Angulat Torque màx: 30 Ncm



		Standard Ø3.75	Wide Ø4.50
17°	H 2.0 mm	AU49-301217	AU49-401217-2
	H 3.0 mm	AU49-301217-3	AU49-401217-3
	H 4.0 mm	AU49-301217-4	AU49-401217-4
30°	H 4.0 mm	AU49-301230	AU49-401230-4
	H 5.0 mm	AU49-301230-5	AU49-401230-5
	H 6.0 mm	AU49-301230-6	AU49-401230-6



Veure components Multi-Use a la pàgina 46

Pilar Elitor Recte Torque màx: 30 Ncm



	Narrow Ø3.30	Standard Ø3.75	Wide Ø4.50
H 0.0 mm	-	AU65-PA350	AU65-PA450
H 1.0 mm	AU65-MIS331	AU65-PA351	AU65-PA451
H 2.0 mm	AU65-MIS332	AU65-PA352	AU65-PA452
H 3.0 mm	AU65-MIS333	AU65-PA353	AU65-PA453
H 4.0 mm	AU65-MIS334	AU65-PA354	AU65-PA454
H 5.0 mm	AU65-MIS335	AU65-PA355	AU65-PA455
H 6.0 mm	AU65-MIS336	AU65-PA356	AU65-PA456



Veure components Elitor a la pàgina 47

Pilar Elitor Angulat Torque màx: 30 Ncm



		Standard Ø3.75
15°	H 1.5 mm	AU65-PA35A1515
	H 3.0 mm	AU65-PA35A1530



Veure components Elitor a la pàgina 47

Base Cr-Co Angularable



	Narrow Ø3.30	Standard Ø3.75	Wide Ø4.50
Antirrotatori	-	AU49-300410	AU49-400410
Rotatori	-	AU49-300460	AU49-400460



Cargol no inclòs a l'envàs

Cargol Clínic Angularable Torque màx: 25 Ncm



Connexió	Narrow Ø3.30	Standard Ø3.75	Wide Ø4.50
Tetralobular	-	AU49-E30050	AU49-E30050
Angled Grip [®]	-	AU49-E30060	AU49-E30060



Veure eines a la pàgina 48

Xemeneia Calcínable Angularada



	Standard Ø3.75	Wide Ø4.50
17°	AU67-001701	AU67-001701
30°	AU67-003001	AU67-003001



Interfases Angulables



		Standard Ø3.75	Wide Ø4.50
Antirrotatori	H 0.5 mm	AU49-300600-05	AU49-400600-05
	H 1.5 mm	AU49-300600-15	-
	H 3.0 mm	AU49-300600-30	-
Rotatori	H 0.5 mm	AU49-300650-05	AU49-400650-05
	H 1.5 mm	AU49-300650-15	-
	H 3.0 mm	AU49-300650-30	-



Cargol no inclòs a l'envàs

Scanbody



	Narrow Ø3.30	Standard Ø3.75	Wide Ø4.50
-	-	AU49-302201	AU49-402201



Cargol no inclòs a l'envàs

Rèplica Digital



	Narrow Ø3.30	Standard Ø3.75	Wide Ø4.50
-	-	AU49-300010	AU49-400010





Neodent® GM

Plataforma:
Ø3.50 (Plataforma Única)

Connexió Cargol Clínic:
NEO

Compatible amb:
Neodent GM*

Pilar Cicatrització Torque màx: 20 Ncm



	Ø3.50	
Perfil Emergència	Ø3.50	Ø4.50
H 2.0 mm	AU35-352120-35	AU35-352120-45
H 3.5 mm	AU35-352135-35	AU35-352135-45
H 5.0 mm	AU35-352150-35	AU35-352150-45

Coping Impressió



	Ø3.50
Cubeta Abierta	AU35-350090



Cargol Clínic Torque màx: 25 Ncm



	Ø3.50
NEO	AU35-350058
Normal	AU35-350058
DLC	-



Rèplica



	Ø3.50
	AU35-350015



Veure eines a la pàgina 48

Calcinable (POM C)



	Ø3.50
Antirrotatori	AU35-350200
Rotatori	AU35-350250



Cargol no inclòs a l'envàs

Calcinable amb Base Cr-Co



	Ø3.50
Antirrotatori	AU35-350400
Rotatori	AU35-350450



Cargol no inclòs a l'envàs

Pilar Multi-Use Recte Torque màx: 30 Ncm



	Ø3.50
H 0.8 mm	AU35-351008
H 1.5 mm	AU35-351015
H 2.5 mm	AU35-351025
H 3.5 mm	AU35-351035
H 4.5 mm	AU35-351045
H 5.5 mm	AU35-351055



Veure components Multi-Use a la pàgina 46

Pilar Multi-Use Angulat Torque màx: 30 Ncm



	Ø3.50	
17°	H 2.5 mm	AU35-351217-25
	H 3.5 mm	AU35-351217-35
30°	H 3.5 mm	AU35-351230-35
	H 4.5 mm	AU35-351230-45



Veure components Multi-Use a la pàgina 46

Pilar Elitor Recte Torque màx: 30 Ncm



	Ø3.50
H 1.0 mm	AU65-GM351
H 2.0 mm	AU65-GM352
H 3.0 mm	AU65-GM353
H 4.0 mm	AU65-GM354
H 5.0 mm	AU65-GM355
H 6.0 mm	AU65-GM356



Pilar Provisional



	Ø3.50
Antirrotatorio	AU35-350300
Rotatorio	AU35-350350



Cargol no inclòs a l'envàs



Neodent® CM

Plataforma:
Ø3.50 / Ø4.50 / Ø5.50 (UNIVERSAL)

Connexió Cargol Clínic:
Hexagonal 0.90

Compatible amb:
Neodent CM*

Pilar Cicatrització Torque màx: 20 Ncm



	UNIVERSAL	
Perfil Emergència	Ø3.50	Ø4.50



H 2.0 mm	AU28-352120-D35	AU28-352120-D45
H 3.5 mm	AU28-352135-D35	AU28-352135-D45
H 5.0mm	AU28-352150-D35	AU28-352150-D45

Coping Impressió



	UNIVERSAL
Cubeta Oberta	AU28-350090



Rèplica



	UNIVERSAL
	AU28-350015



Cargol Clínic Torque màx: 25 Ncm



	UNIVERSAL
Hex. 0.9	M1.8
Normal	AU28-350051



Pilar Provisional Torque màx: 25 Ncm



	UNIVERSAL
Antirrotatori	AU28-350300
Rotatori	AU27-350350



Veure eines a la pàgina 48

Cargol no inclòs a l'envàs

Calcinable (POM C)



	UNIVERSAL
Antirrotatori	AU28-350200
Rotatori	AU28-350250



Cargol no inclòs a l'envàs

Pilar Elitor Recte Torque màx: 30 Ncm



	UNIVERSAL
H 2.0 mm	AU65-NCM352
H 3.0 mm	AU65-NCM353
H 4.0 mm	AU65-NCM354
H 5.0 mm	AU65-NCM355
H 6.0 mm	AU65-NCM356



Veure components Elitor a la pàgina 47

Pilar Multi-Use Recte Torque màx: 30 Ncm



	UNIVERSAL
H 1.5 mm	AU28-351015
H 2.5 mm	AU28-351025
H 3.5 mm	AU28-351035
H 4.5 mm	AU28-351045
H 5.5 mm	AU28-351055



Veure components Multi-Use a la pàgina 46

Pilar Multi-Use Angulat Torque màx: 30 Ncm



		UNIVERSAL
17°	H 2.5 mm	AU28-351217-25
	H 3.5 mm	AU28-351217-35
30°	H 3.5 mm	AU28-351230-35
	H 4.5 mm	AU28-351230-45



Veure components Multi-Use a la pàgina 46



Nobel Biocare® Brånemark System®

Plataformes:

NP Ø3.5 / RP Ø4.1 / WP Ø5.1

Connexió Cargol Clínic:

Unigrip® / Hexagonal 1.20 / Hexagonal 1.25 / Cuadrada 1.30

Compatible amb:

Nobel Biocare Brånemark® / Eckerman® / Phibo-DefconTSH® (S3, S4) / Avinent® EC (4.1, 5.1) / BTI EXTERNA 4.1

Pilar Cicatrització Torque màx: 20 Ncm



Perfil Emergència	NP Ø3.50		RP Ø4.10		WP Ø5.10	
	Ø3.50	Ø4.50	Ø4.1	Ø5.50	Ø5.1	Ø6.0
H 2.0 mm	-	-	AU44-002120	AU44-002120-50	-	-
H 3.0 mm	AU44-332130	AU44-332130-D45	AU44-002130	AU44-002130-50	AU44-502130	AU44-502130-D60
H 4.0 mm	-	-	AU44-002140	AU44-002140-50	-	-
H 5.0 mm	AU44-332150	AU44-332150-D45	AU44-002150	AU44-002150-50	AU44-502150	AU44-502150-D60

Coping Impressió



Rèplica



	NP Ø3.50	RP Ø4.10	WP Ø5.10
Cubeta Abierta	AU44-330090	AU44-000090	AU44-500090
Cubeta Cerrada	-	AU44-000080	-
1.20	-	AU44-000190	-



	NP Ø3.50	RP Ø4.10	WP Ø5.10
	AU44-330015	AU44-000015	AU44-500015



Cargol Clínic Torque màx:25 Ncm



	NP Ø3.50	RP Ø4.10	WP Ø5.10
Unigrip	M1.6	M2	M2.5
Normal	AU44-330057	AU44-E00057	AU44-500057
DLC	AU44-330057-N	AU44-E00057-N	AU44-500057-N
As. Plano	-	AU44-E00157	-

	NP Ø3.50	RP Ø4.10	WP Ø5.10
Hexagonal 1.20	M1.6	M2	M2.5
Normal	-	AU44-E00054	AU44-500054
DLC	-	AU44-E00054-N	AU44-500054-N

	NP Ø3.50	RP Ø4.10	WP Ø5.10
Hexagonal 1.25	M1.6	M2	M2.5
Normal	-	AU44-E00052	-
DLC	-	AU44-E00052-N	-

	NP Ø3.50	RP Ø4.10	WP Ø5.10
Quadrat 1.30	M1.6	M2	M2.5
Normal	-	AU44-E00053	-
DLC	-	AU44-E00053-N	-



Veure eines a la pàgina 48

Calcinable (POM C)



	NP Ø3.50	RP Ø4.10	WP Ø5.10
Antirrotatori	AU44-330200	AU44-E00200	AU44-500200
Rotatori	AU44-330250	AU44-E00250	AU44-500250



Cargol no inclòs a l'envàs

Calcinable amb Base Cr-Co



	NP Ø3.50	RP Ø4.10	WP Ø5.10
Antirrotatori	AU44-330500	AU44-000400	AU44-500400
Rotatori	AU44-330550	AU44-000450	AU44-500450



Cargol no inclòs a l'envàs

Pilar Provisional



		NP Ø3.50	RP Ø4.10	WP Ø5.10
TITANI	Antirrotatori	AU44-330300	AU44-000300	AU44-500300
	Rotatori	AU44-330350	AU44-000350	AU44-500350



Cargol no inclòs a l'envàs

		NP Ø3.50	RP Ø4.10	WP Ø5.10
PEEK	Antirrotatori	-	AU44-000500	-
	Rotatori	-	AU44-000550	-



Cargol no inclòs a l'envàs

Pilar Cimentable Recte



	Ø3.50	Ø4.10	Ø5.10
Antirrotatori	AU44-331320	AU44-001320	-
Rotatori	AU44-331330	AU44-001330	-



Cargol no inclòs a l'envàs

Pilar Cimentable Angulat



		Ø3.50	Ø4.10	Ø5.10
15°	H 1.5 mm	AU44-331515-15	AU44-001515-15	AU44-501515-15
25°	H 2.0 mm	-	AU44-001525-2	-



Cargol no inclòs a l'envàs

Pilar Multi-Use Recte Torque màx: 30 Ncm



	NP Ø3.50	RP Ø4.10	WP Ø5.10
H 1.0 mm	AU43-351010	AU43-501010-CA	AU43-601010
H 2.0 mm	AU43-351020	AU43-501020-CA	AU43-601020
H 3.0 mm	AU43-351030	AU43-501030-CA	AU43-601030
H 4.0 mm	-	AU43-501040-CA	-
H 5.0 mm	-	AU43-501050-CA	-



Veure components Multi-Use a la pàgina 46

Pilar Multi-Use Angulat Torque màx: 30 Ncm



		NP Ø3.50	RP Ø4.10
17°	H 2.0 mm	AU43-351217-2	AU43-501217-2
	H 3.0 mm	AU43-351217-3	AU43-501217-3
	H 4.0 mm	AU43-351217-4	AU43-501217-4
30°	H 3.0 mm	AU43-351230-3	AU43-501230-3
	H 4.0 mm	AU43-351230-4	AU43-501230-4
	H 5.0 mm	-	AU43-501230-5



Veure components Multi-Use a la pàgina 46

Pilar Elitor Recte Torque màx: 30 Ncm



	NP Ø3.50	RP Ø4.10	WP Ø5.10
H 1.0 mm	AU65-00B331	AU65-00B401	AU65-00B501
H 2.0 mm	AU65-00B332	AU65-00B402	AU65-00B502
H 3.0 mm	AU65-00B333	AU65-00B403	AU65-00B503
H 4.0 mm	AU65-00B334	AU65-00B404	AU65-00B504
H 5.0 mm	AU65-00B335	AU65-00B405	AU65-00B505
H 6.0 mm	-	AU65-00B406	-



Veure components Elite a la pàgina 47

Pilar Elitor Angulat Torque màx: 30 Ncm



		RP Ø4.10
15°	H 1.0 mm	AU65-B401A1515
	H 2.0 mm	AU65-B401A1530



Veure components Elite a la pàgina 47

Cargol Clínic Angulable Torque màx: 25 Ncm



	NP Ø3.50	RP Ø4.10	WP Ø5.10
Connexió	M1.6	M2	M2.5
Tetralobular	AU44-330050	AU44-E00050	-
Angled Grip*	-	AU44-E00060	-



Veure eines a la pàgina 48

Base Cr-Co Angulable



	NP Ø3.50	RP Ø4.10	WP Ø5.10
Antirrotatori	AU44-330410	AU44-000410	-
Rotatori	AU44-330460	AU44-000460	-



Xemeneia Calcinable Angulada



NP Ø3.50	RP Ø4.10	WP Ø5.10
AU67-001701	AU67-001701	-



NP Ø3.50	RP Ø4.10	WP Ø5.10
AU67-003001	AU67-003001	-



Interfase Angulable



	NP Ø3.50	RP Ø4.10
Antirrotatori	H 0.5 mm	AU44-330600-05
	H 1.5 mm	-
	H 2.5 mm	AU44-000600-15
Rotatori	H 2.5 mm	AU44-000600-25
	H 3.5 mm	AU44-000600-35
	H 0.5 mm	AU44-330650-05
	H 1.5 mm	-
	H 2.5 mm	AU44-000650-15
	H 3.5 mm	AU44-000650-35



Cargol no inclòs a l'envàs

Scanbody



NP Ø3.50	RP Ø4.10	WP Ø5.10
AU44-332201	AU44-412201	-

Cargol no inclòs a l'envàs



Rèplica Digital



NP Ø3.50	RP Ø4.10	WP Ø5.10
AU44-330010	AU44-000010	-



Lorem ipsum

Sistema Transepitelial Estheticone

Pilar Estheticone Recte



	NP Ø3.50	RP Ø4.10	WP Ø5.10
H 1.0 mm	-	AU43-201010	-
H 2.0 mm	-	AU43-201020	-
H 3.0 mm	-	AU43-201030	-



Components Estheticone

	RP Ø4.10
Tap de Cicatrització Titani	CE 0051 AU43-200004
Rèplica	CE AU43-200015
Calcinable (POM-C) Antirrotatori	CE AU43-200200
Coping d'Impressió Cubeta Oberta	CE AU43-200090
Provisional Antirrotatori	CE 0051 AU43-200300

Cargol Clinic Estheticone

Torque màx:25 Ncm



	NP Ø3.50	RP Ø4.10	WP Ø5.10
Unigrip		M1.4	
	Normal	AU43-E50057	-
	DLC	AU43-E50057-N	-

Hexagonal 1.27

	NP Ø3.50	RP Ø4.10	WP Ø5.10
Hexagonal 1.27		M1.4	
	Normal	AU43-E50056	-
	DLC	AU43-500056-N	-



Veure eines a la pàg. 48



Nobel Replace[®] Select

Plataforma:

NP Ø3.50 / RP Ø4.30 / WP Ø5.00

Connexió Cargol Clínic:

Unigrip

Compatible amb:

Nobel Biocare[®] Select Replace[®] i altres

Coping Impressió



	NP Ø3.50	RP Ø4.30	WP Ø5.00
Cubeta Oberta	AU54-350090	AU54-430090	AU54-500090



Rèplica



	NP Ø3.50	RP Ø4.30	WP Ø5.00
	AU54-350015	AU54-430015	AU54-500015



Cargol Clínic Torque màx: 25 Ncm



	NP Ø3.50	RP Ø4.30	WP Ø5.00
Unigrip[®]	M 1.8	M 2	M 2
Normal	AU54-350057	AU54-430057	AU54-430057
DLC	AU54-350057-N	AU54-430057-N	AU54-430057-N



Veure eines a la pàgina 48

Calcinable (POM C)



	NP Ø3.50	RP Ø4.30	WP Ø5.00
Antirrotatori	AU54-350200-B	AU54-430200-B	AU54-500200-B
Rotatori	AU54-350250-B	AU54-430250-B	AU54-500250-B



Cargol no inclòs a l'envàs

Calcinable amb Base Cr-Co



	NP Ø3.50	RP Ø4.30	WP Ø5.00
Antirrotatori	AU54-350400	AU54-430400	AU54-500400
Rotatori	AU54-350450	AU54-430450	AU54-500450



Cargol no inclòs a l'envàs

Pilar Provisional



	NP Ø3.50	RP Ø4.30	WP Ø5.00
Antirrotatori	AU54-350300	AU54-430300	AU54-500300
Rotatori	AU54-350350	AU54-430350	AU54-500350



Cargol no inclòs a l'envàs

Pilar Multi-Use Recte Torque màx: 30 Ncm



	NP Ø3.50	RP Ø4.30	WP Ø5.00
H 1.0 mm	AU54-351010	AU54-431010	AU54-501010
H 2.0 mm	AU54-351020	AU54-431020	AU54-501020
H 3.0 mm	AU54-351030	AU54-431030	AU54-501030
H 4.0 mm	-	AU54-431040	-
H 5.0 mm	-	AU54-431050	-



Veure components Multi-Use a la pàgina 46

Pilar Multi-Use Angulat Torque màx: 30 Ncm



	NP Ø3.50	RP Ø4.30
H 2.0 mm	AU54-351217	AU54-431217-2
17°	H 3.0 mm AU54-351217-3	AU54-431217-3
	H 4.0 mm -	AU54-431217-4
	H 4.0 mm -	AU54-431230-4
30°	H 5.0 mm -	AU54-431230-5



Veure components Multi-Use a la pàgina 46

Pilar Elitor Recte Torque màx: 30 Ncm

	NP Ø3.50	RP Ø4.30	WP Ø5.00
H 0.0 mm	AU65-SRS350	AU65-SRS430	-
H 1.0 mm	AU65-SRS351	AU65-SRS431	AU65-SRS501
H 2.0 mm	AU65-SRS352	AU65-SRS432	AU65-SRS502
H 3.0 mm	AU65-SRS353	AU65-SRS433	AU65-SRS503
H 4.0 mm	AU65-SRS354	AU65-SRS434	AU65-SRS504
H 5.0 mm	AU65-SRS355	AU65-SRS435	AU65-SRS505
H 6.0 mm	AU65-SRS356	AU65-SRS436	-



Veure components Elitor a la pàgina 47

Scanbody

NP Ø3.50	RP Ø4.30	WP Ø5.00
AU54-352201	AU54-432201	AU54-502201



Cargol no inclòs a l'envàs

Rèplica Digital

NP Ø3.50	RP Ø4.30	WP Ø5.00
AU54-350010	AU54-430010	AU54-500010

**Cargol Clínic Angularable** Torque màx: 25 Ncm

	NP Ø3.50	RP Ø4.30	WP Ø5.00
Connexió	M1.8	M2	M2
Tetralobular	AU54-350050	AU54-430050	AU54-430050



Veure eines a la pàgina 48

Base Cr-Co Angularable

	NP Ø3.50	RP Ø4.30	WP Ø5.00
Antirrotatori	AU54-350410	AU54-430410	AU54-500410
Rotatori	AU54-350460	AU54-430460	AU54-500460



Cargol no inclòs a l'envàs

Interfases Angularables

	Ø3.3	Ø3.8	Ø4.25
Antirrotatori	H 0.5 mm AU54-350600-05	AU54-430600-05	AU54-500600-05
Rotatori	H 0.5 mm AU54-350650-05	AU54-430650-05	AU54-500650-05



Cargol no inclòs a l'envàs

Xemeneia Calcinable Angularada

	NP Ø3.50	RP Ø4.30	WP Ø5.00
17°	AU67-001701	AU67-001701	AU67-001701
30°	AU67-003001	AU67-003001	AU67-003001





Nobel Biocare® Nobel Active®

Plataformes:

MiP Ø3.0 / NP Ø3.50 / RP Ø4.30

Connexió Cargol Clínic:

Unigrip®

Compatible amb:

Nobel Biocare® Nobel Active® i y altres.

Pilar Cicatrització Torque màx: 20 Ncm



	MiP Ø3.00	NP Ø3.50		RP Ø4.30	
Perfil Emergència	Ø3.60	Ø3.60	Ø5.00	Ø3.90	Ø5.00
H 3.0 mm	AU25-302130	AU25-352130	AU25-352130-D50	AU25-432130	AU25-432130-D50
H 5.0 mm	AU25-302150	AU25-352150	AU25-352150-D50	AU25-432150	AU25-432150-D50
H 7.0 mm	AU25-302170	AU25-352170	AU25-352170-D50	AU25-432170	AU25-432170-D50

Coping Impressió



	MiP Ø3.00	NP Ø3.50	RP Ø4.30
Cubeta Oberta	AU25-300090	AU25-350090	AU25-430090



Rèplica



	MiP Ø3.00	NP Ø3.50	RP Ø4.30
	AU25-300015	AU25-350015	AU25-430015



Cargol Clínic

Torque màx: 25 Ncm



	MiP Ø3.00	NP Ø3.50	RP Ø4.30
Unigrip®	M1.4	M1.6	M2
Normal	AU25-300057	AU25-350057	AU25-430057
DLC	AU25-300057-N	AU25-350057-N	AU25-430057-N



Pilar Provisional



	MiP Ø3.00	NP Ø3.50	RP Ø4.30
Antirrotatori	AU25-300300	AU25-350300	AU25-430300
Rotatori	AU25-300350	AU25-350350	AU25-430350



Cargol no inclòs a l'envàs

Veure eines a la pàgina 48

Calcinable amb Base Cr-Co



	MiP Ø3.00	NP Ø3.50	RP Ø4.30
Antirrotatori	AU25-300400	AU25-350400	AU25-430400
Rotatori	AU25-300450	AU25-350450	AU25-430450



Cargol no inclòs a l'envàs

Calcinable (POM C)



	MiP Ø3.00	NP Ø3.50	RP Ø4.30
Antirrotatori	AU25-300200	AU25-350200	AU25-430200
Rotatori	AU25-300250	AU25-350250	AU25-430250



Cargol no inclòs a l'envàs

Pilar Cimentable Recte Torque màx: 30 Ncm

	MiP Ø3.00	NP Ø3.50	RP Ø4.30
H 1.5 mm	-	AU25-351321	-
H 2.5 mm	-	AU25-351322	-
H 3.5 mm	-	AU25-351323	-
H 4.5 mm	-	AU25-351324	-
H 5.5 mm	-	AU25-351325	-
H 6.5 mm	-	AU25-351326	-



Cargol no inclòs a l'envàs

Pilar Cimentable Angulat Torque màx: 30 Ncm

		NP Ø3.50
15°	H 1.0 mm	AU25-351515-1
	H 2.0 mm	AU25-351515-2
	H 3.0 mm	AU25-351515-3
25°	H 1.0 mm	AU25-351525-1
	H 2.0 mm	AU25-351525-2
	H 3.0 mm	AU25-351525-3



Cargol no inclòs a l'envàs

Pilar Multi-Use Recte Torque màx: 30 Ncm

	MiP Ø3.00	NP Ø3.50	RP Ø4.30
H 1.5 mm	-	AU25-351015	AU25-431015
H 2.5 mm	-	AU25-351025	AU25-431025
H 3.5 mm	-	AU25-351035	AU25-431035
H 4.5 mm	-	AU25-351045	AU25-431045
H 5.5 mm	-	AU25-351055	AU25-431055
H 6.5 mm	-	AU25-351065	AU25-431065



Veure components Multi-Use a la pàgina 46

Pilar Multi-Use Angulat Torque màx: 30 Ncm

		NP Ø3.50	RP Ø4.30
17°	H 2.5 mm	AU25-351217-25	AU25-431217-25
	H 3.5 mm	AU25-351217-35	AU25-431217-35
30°	H 3.5 mm	AU25-351230-35	AU25-431230-35
	H 4.5 mm	AU25-351230-45	AU25-431230-45



Veure components Multi-Use a la pàgina 46

Pilar Elitor Recte Torque màx: 30 Ncm

	MiP Ø3.00	NP Ø3.50	RP Ø4.30
H 1.0 mm	-	AU65-NA351	AU65-NA451
H 2.0 mm	-	AU65-NA352	AU65-NA452
H 3.0 mm	-	AU65-NA353	AU65-NA453
H 4.0 mm	-	AU65-NA354	AU65-NA454
H 5.0 mm	-	AU65-NA355	AU65-NA455
H 6.0 mm	-	AU65-NA356	AU65-NA456



Veure components Elitor a la pàgina 47

Scanbody

MiP Ø3.00	NP Ø3.50	RP Ø4.30
AU25-302201	AU25-352201	AU25-432201
	AU25-352202 (Largo)	



Cargol no inclòs a l'envàs

Rèplica Digital

MiP Ø3.00	NP Ø3.50	RP Ø4.30
AU25-300010	AU25-350010	AU25-430010

**Cargol Clínic Angulable** Torque màx: 25 Ncm

	MiP Ø3.00	NP Ø3.50	RP Ø4.30
		M1.6	M2
Tetralobular	-	AU25-350050	AU25-430050
Angled Grip®	-	AU25-350060	AU25-430060



Veure eines a la pàgina 48

Base Cr-Co Angulable

	MiP Ø3.00	NP Ø3.50	RP Ø4.30
Antirrotatori	-	AU25-350410	AU25-430410
Rotatori	-	AU25-350460	AU25-430460



Cargol no inclòs a l'envàs

Xemeneia Calcinable Angulada

	MiP Ø3.00	NP Ø3.50	RP Ø4.30
-	-	AU67-001701	AU67-001701



	NP Ø3.50	RP Ø4.10	WP Ø5.10
-	-	AU67-003001	AU67-003001

**Interfase Angulable**

		MiP Ø3.00	NP Ø3.50	RP Ø4.30
Antirrotatori	H 1.5 mm	AU25-300600-15	AU25-350600-15	AU25-430600-15
	H 2.5 mm	-	AU25-350600-25	-
	H 3.5 mm	-	AU25-350600-35	-
Rotatori	H 1.5 mm	AU25-300650-15	AU25-350650-15	AU25-430650-15
	H 2.5 mm	-	AU25-350650-25	-
	H 3.5 mm	-	AU25-350650-35	-



Tornillo no incluido en el envase



Osstem Implant®

Plataforma:
RP Ø4.00/ Ø4.50 / Ø5.50

Connexió Cargol Clínic:
Hexagonal 1.20

Compatible amb:
Osstem Implant®

Pilar Cicatrització Torque màx: 20 Ncm



UNIVERSAL

Perfil Emergència

Ø5.50

Ø6.50



H 2.0 mm	AU23-402120-55	AU23-402120-65
H 4.0 mm	AU23-402140-55	AU23-402140-65
H 6.0 mm	AU23-402160-55	AU23-402160-65

Rèplica

Ø4.00 / Ø4.50/ Ø5.50

AU23-400015



Coping Impressió



UNIVERSAL

Cubeta Oberta

AU23-400090



Calcinable amb Base Cr-Co



Ø4.00 / Ø4.50/ Ø5.50

Antitrotatori	AU23-400400
Rotatori	AU23-40450



Cargol no inclòs a l'envàs

Cargol Clínic Torque màx:25 Ncm



Ø4.00 / Ø4.50/ Ø5.50

Hex. 1.20

M2

Normal

AU23-400054

Veure eines a la pàgina 48



Calcinable (POM C)



Ø4.00 / Ø4.50/ Ø5.50

Antitrotatori	AU23-400200
Rotatori	AU23-400250



Cargol no inclòs a l'envàs

Pilar Multi-Use Recte Torque màx: 30 Ncm



Ø4.00 / Ø4.50/ Ø5.50

H 1.5 mm	AU23-401015
H 2.5 mm	AU23-401025
H 3.5 mm	AU23-401035
H 4.5 mm	AU23-401045
H 5.5 mm	AU23-401055



Ver
components
Multi-Use en
pag.-

Pilar Multi-Use Angulat Torque màx: 30 Ncm



Ø4.00 / Ø4.50/ Ø5.50

17°	H 2.5 mm	AU23-401217-25
	H 3.5 mm	AU23-401217-35
30°	H 3.5 mm	AU23-401230-35
	H 4.5 mm	AU23-401230-45



Veure components Multi-Use a la pàgina 46

Pilar Elitor Recte Torque màx: 30 Ncm



Ø4.00 / Ø4.50/ Ø5.50

H 1.0 mm	AU65-OSS401
H 2.0 mm	AU65-OSS402
H 3.0 mm	AU65-OSS403
H 4.0 mm	AU65-OSS404
H 5.0 mm	AU65-OSS405



Veure
components
Elitor a la
pàgina 47

Pilar Provisional



Ø4.00 / Ø4.50/ Ø5.50

Antitrotatori	AU23-400300
Rotatori	AU23-400350



Xemeneia Calcinable Angulada



Ø4.00 / Ø4.50/ Ø5.50

AU67-001701



Ø4.00 / Ø4.50/ Ø5.50

AU67-003001





Straumann® Bone Level

Plataformes:

NC Ø3.3 / RC Ø4.1

Connexió Cargol Clínic:



Torx.

Compatible amb:

Straumann® Bone Level® y otros.

Pilar Cicatrització Torque màx: 20 Ncm



Perfil Emergència	NC Ø3.30		RC Ø4.10	
	Ø4.00	Ø5.00	Ø6.00	
H 2.0 mm				AU34-332120
H 4.0 mm	AU34-332140	AU34-412140	AU34-412140-D60	
H 6.0 mm	AU34-332160	AU34-412160	AU34-412160-D60	

Coping Impressió



Rèplica



	NC Ø3.30	RC Ø4.10
Cubeta Oberta	AU34-330090	AU34-410090
Cubeta Tancada	-	-



	NC Ø3.30	RC Ø4.10
	AU34-330015	AU34-410015



Cargol Clínic Torque màx: 25 Ncm



Pilar Provisional



	NC Ø3.30	RC Ø4.10
Torx	M1.6	M1.6
Normal	AU34-330059	AU34-400059
DLC	AU34-330059-N	AU34-400059-N



	NC Ø3.30	RC Ø4.10
Antirrotatori	AU34-330300	AU34-410300
Rotatori	AU34-330350	AU34-410350



Cargol no inclòs a l'envàs

Veure eines a la pàgina 48

Calcinable amb Base Cr-Co



Calcinable (POM C)



	NC Ø3.30	RC Ø4.10
Antirrotatori	AU34-330400	AU34-410400
Rotatori	AU34-330450	AU34-410450



	NC Ø3.30	RC Ø4.10
Antirrotatori	AU34-330200	AU34-410200
Rotatori	AU34-330250	AU34-410250



Cargol no inclòs a l'envàs

Cargol no inclòs a l'envàs

Pilar Multi-Use Recte Torque màx: 30 Ncm



	NC Ø3.30	RC Ø4.10
H 1.5 mm	AU34-331015	AU34-411015
H 2.5 mm	AU34-331025	AU34-411025
H 3.5 mm	AU34-331035	AU34-411035
H 4.5 mm	AU34-331045	AU34-411045



Veure components Multi-Use a la pàgina 46

Pilar Multi-Use Angulat Torque màx: 30 Ncm



	NC Ø3.30	RC Ø4.10
17°	H 2.5 mm	AU34-331217-2 AU34-411217-2
	H 3.5 mm	AU34-331217-3 AU34-411217-3
30°	H 3.5 mm	AU34-331230-3 AU34-411230-3
	H 4.5 mm	AU34-331230-4 AU34-411230-4



Veure components Multi-Use a la pàgina 46

Pilar Elitor Recte Torque màx: 30 Ncm



	NC Ø3.30	RC Ø4.10
H 1.0 mm	AU65-CF331	AU65-CF401
H 2.0 mm	AU65-CF332	AU65-CF402
H 3.0 mm	AU65-CF333	AU65-CF403
H 4.0 mm	AU65-CF334	AU65-CF404
H 5.0 mm	AU65-CF335	AU65-CF405
H 6.0 mm	AU65-CF336	AU65-CF406



Veure components Elitor a la pàgina 47

Scanbody



NC Ø3.30	RC Ø4.10
AU34-332201	AU34-412201



Cargol no inclòs a l'envàs

Rèplica Digital



NC Ø3.30	RC Ø4.10
AU34-330010	AU34-410010



Cargol Clínic Angulable Torque màx: 25 Ncm



	NC Ø3.30	RC Ø4.10
Connexió	M1.6	
Tetralobular	AU34-330050	AU34-330050
Angled Grip*	AU34-330060	-



Veure eines a la pàgina 48

Xemeneia Calcínable Angulada



	NC Ø3.30	RC Ø4.10
17°	AU67-001701	AU67-001701
30°	AU67-003001	AU67-003001



Interfase



	H 1.5 mm	NC Ø3.30	RC Ø4.10
Antirrotatori		AU34-330600-15	AU34-410600-15
Rotatori		AU34-330650-15	AU34-410650-15



Cargol no inclòs a l'envàs

Base Cr-Co Angulable



	NC Ø3.30	RC Ø4.10
Antirrotatori	AU34-330410	AU34-410410
Rotatori	AU34-330460	AU34-410460



Cargol no inclòs a l'envàs

Components Sistema SRA



	Ø4.60
Pilar Calcitrización Peek	CE 0051 AU34-462100
Coping Impressió Cubeta Oberta	CE 0051 AU34-460090
Rèplica	CE 0051 AU34-460015
Pilar Provisional Rotatori	CE 0051 AU34-460350
Cargols Torx M1.4	CE 0051 AU34-460059
Calínable Rotatori	CE 0051 AU34-460250



Straumann® Tissue Level

Plataformes:

RN Ø4.8 0/ WN Ø6.50

Connexió Cargol Clínic:

Torx

Compatible amb:

Straumann® Tissue Level® i altres

Pilar Cicatrització Torque màx: 20 Ncm



Perfil Emergència	RN Ø4.80
	Ø5.5
H 2.0 mm	AU33-482120-D55
H 3.0 mm	AU33-482130-D55
H 4.5 mm	AU33-482145-D55



Coping Impressió



	RN Ø4.80	WN Ø6.50
Cubeta Oberta	AU33-480090	AU33-650090



Rèplica



RN Ø4.80	WN Ø6.50
AU33-480015	AU33-650015



Cargol Clínic Torque màx: 25 Ncm



	RN Ø4.80		WN Ø6.50	
	Torx	M2	M2	
PER A CALCINABLE (POMC)	Normal	AU33-480059	AU33-480059	
	DLC	AU33-480059T	AU33-480059T	
PER A CR-CO i PROVISIONAL	Normal	AU33-480055	AU33-480055	
	DLC	AU33-480055T	AU33-480055T	



Veure eines a la pàgina 48

Calcinable (POM C)



	RN Ø4.80	WN Ø6.50
Antirotatori	AU33-480200	AU33-650200
Rotatori	AU33-480250	AU33-650250



Cargol no inclòs a l'envàs

Calcinable amb Base Cr-Co



	RN Ø4.80
Antirotatori	AU33-480400
Rotatori	AU33-480450



Cargol no inclòs a l'envàs

Pilar Massís



	RN Ø4.80
H 4.0 mm	AU33-481240
H 5.5 mm	AU33-481255



Cargol no inclòs a l'envàs

Pilar Massís amb Connexió Clau Ø1.25



	RN Ø4.80
H 4.0 mm	AU33-481440-125
H 5.5 mm	AU33-481455-125
H 7.0 mm	AU33-481470-125



Cargol no inclòs a l'envàs

Pilar Cimentable Recte



RN Ø4.80

AU33-481321

Cargol no inclòs a l'envàs



Pilar Cimentable Angulat



RN Ø4.80

15° AU33-481515-1
30° AU33-481525-1

Cargol no inclòs a l'envàs



Coping Impressió

Per a Pilar Cimentable Recte



RN Ø4.80

AU33-481300

Cargol no inclòs a l'envàs



Calcinable Pick Up

Per a Pilar Cimentable Recte



RN Ø4.80

Antirrotatori AU33-501400
Rotatori AU33-501450



Pilar Multi-Use Recte

Torque màx: 30 Ncm



RN Ø4.80

H 1.0 mm AU33-481010

Veure components Multi-Use a la pàgina 46



Pilar Multi-Use Angulat

Torque màx: 30 Ncm



RN Ø4.80

15° H 2.5 mm AU33-481217-25
30° H 3.5 mm AU33-481230-35

Veure components Multi-Use a la pàgina 46



Pilar Provisional



RN Ø4.80

Antirrotatori AU33-480300 AU33-650300
Rotatori AU33-480350 AU33-650350

Cargol no inclòs a l'envàs



Pilar Elitor Recte

Torque màx: 30 Ncm



RN Ø4.80

H 1.0 mm AU65-00T401
H 2.0 mm AU65-00T402
H 3.0 mm AU65-00T403
H 4.0 mm AU65-00T404
H 5.0 mm AU65-00T405
H 6.0 mm AU65-00T406

Veure components Elitor a la pàgina 47



Pilar Elitor Angulat

Torque màx: 30 Ncm



RN Ø4.80

15° H 1.5 mm AU65-T40A1515

Veure components Elitor a la pàgina 47



Cargol Clínic Angulable

Torque màx: 25 Ncm



RN Ø4.80

Connexió M2
Tetralobular AU33-480050
Angled Grip* AU33-480060

Veure eines a la pàgina 48



Base Cr-Co Angulable



RN Ø4.80

Antirrotatori AU33-480410
Rotatori AU33-480460

Cargol no inclòs a l'envàs



Xemeneia Calcinable Angulada



RN Ø4.80

15° AU67-001701
30° AU67-003001



Interfases Angulables



RN Ø4.80

Antirrotatori H 0.5 mm AU33-480600-05
Rotatori H 0.5 mm AU33-480650-05

Cargol no inclòs a l'envàs



Scanbody



RN Ø4.80

AU33-482201

Cargol no inclòs a l'envàs



Rèplica Digital



RN Ø4.80

AU33-480010

Cargol no inclòs a l'envàs



Pilar Octa



RN Ø4.80

AU33-500010

Cargol no inclòs a l'envàs



Components Sistema Synocta

Pilar Synocta Conversor



RN Ø4.80

Antirotatori AU33-500009

Cargol no inclòs a l'envàs



Coping Impressió Synocta



RN Ø4.80

AU33-500090



Rèplica Sistema Synocta



RN Ø4.80

AU33-500015

Cargol no inclòs a l'envàs



Cargol Clínic Sistema Synocta



RN Ø4.80

M2

Normal AU33-E50059

DLC AU33-E50059-N



Veure eines a la pàgina 48

Calcínable (POM C) Sistema Synocta



RN Ø4.80

Antirotatori AU33-500200

Rotatori AU33-500250

Cargol no inclòs a l'envàs



Calcínable Base Cr-Co Sistema Synocta



RN Ø4.80

Antirotatori AU33-500400

Rotatori AU33-500450

Cargol no inclòs a l'envàs





Sweden Y Martina[®] Premium Kohno[®]

Plataformes:

Ø3.30 / Ø3.80 / Ø4.25

Connexió Cargol Clinic:

Hexagonal 1.27

Compatible amb:

Sweden Y Martina[®] Premium Kohno[®]

Pilar Cicatrització Torque màx: 20 Ncm



	Ø3.30	Ø3.80
Perfil Emergència	Ø3.50	Ø4.50
H 2.0 mm	AU17-332120	AU17-382120
H 3.0 mm	AU17-332130	AU17-382130
H 5.0 mm	AU17-332150	AU17-382150
H 7.0 mm	-	AU17-382170

Coping Impressió



	Ø3.30	Ø3.80	Ø4.25
Cubeta Oberta	AU17-330090	AU17-380090	AU17-420090

Rèplica



	Ø3.30	Ø3.80	Ø4.25
	AU17-330015	AU17-380015	AU17-420015

Cargol Clinic Torque màx: 25 Ncm



	Ø3.30	Ø3.80	Ø4.25
Hex. 1.27	M1.8	M1.8	M2
Normal	AU17-330052	AU17-330052	AU17-420052
DLC	AU17-330052-N	AU17-330052-N	AU17-420052-N



Veure eines a la pàgina 48

Pilar Provisional



	Ø3.30	Ø3.80	Ø4.25
Antirrotatori	AU17-330300	AU17-380300	AU17-420300
Rotatori	AU17-330350	AU17-380350	AU17-420350



Cargol no inclòs a l'envàs

Calcinable amb Base Cr-Co



	Ø3.30	Ø3.80	Ø4.25
Antirrotatori	AU17-330400	AU17-380400	AU17-420400
Rotatori	AU17-330450	AU17-380450	AU17-420450



Cargol no inclòs a l'envàs

Calcinable (POM C)



	Ø3.30	Ø3.80	Ø4.25
Antirrotatori	AU17-330200	AU17-380200	AU17-420200
Rotatori	AU17-330250	AU17-380250	AU17-420250



Cargol no inclòs a l'envàs

Pilar Multi-Use Recte Torque màx: 30 Ncm



	Ø3.30	Ø3.80	Ø4.25
H 1.0 mm	AU17-331010	AU17-381010	AU17-421010
H 2.0 mm	AU17-331020	AU17-381020	AU17-421020
H 3.0 mm	AU17-331030	AU17-381030	AU17-421030
H 4.0 mm	AU17-331040	AU17-381040	AU17-421040



Veure components Multi-Use a la pàgina 46

Pilar Multi-Use Angulat Torque màx: 30 Ncm



	Ø3.3	Ø3.8	Ø4.25
H 2.5 mm	AU17-331217-2	AU17-381217-2	AU17-421217-2
17°	H 3.5 mm AU17-331217-3	AU17-381217-3	AU17-421217-3
	H 4.5 mm AU17-331217-4	AU17-381217-4	AU17-421217-4
30°	H 3.5 mm AU17-331230-3	AU17-381230-3	AU17-421230-3
	H 4.5 mm AU17-331230-4	AU17-381230-4	AU17-421230-4



Veure components Multi-Use a la pàgina 46

Pilar Elitor Recte Torque màx: 30 Ncm

	Ø3.30	Ø3.80	Ø4.25
H 1.0 mm	AU65-PK331	AU65-PK381	AU65-PK4251
H 2.0 mm	AU65-PK332	AU65-PK382	AU65-PK4252
H 3.0 mm	AU65-PK333	AU65-PK383	AU65-PK4253
H 4.0 mm	AU65-PK334	AU65-PK384	AU65-PK4254
H 5.0 mm	-	AU65-PK385	AU65-PK4255
H 6.0 mm	-	-	AU65-PK4256



Veure components Elitor a la pàgina 47

Base Cr-Co Angular

	Ø3.30	Ø3.80	Ø4.25
Antirrotatori	AU17-330410	AU17-380410	AU17-420410
Rotatori	AU17-330460	AU17-380460	AU17-420460



Cargol no inclòs a l'envàs

Cargol Clínic Angular Torque màx: 25 Ncm

	Ø3.30	Ø3.80	Ø4.25
Conexión	M1.8	M1.8	M2
TETRALOBULAR	AU17-330050	AU17-330050	AU17-420050



Veure eines a la pàgina 48

Xemeneia Calcinable Angular

	Ø3.30	Ø3.80	Ø4.25
17°	AU67-001701	AU67-001701	AU67-001701
30°	AU67-003001	AU67-003001	AU67-003001

**Interfases Angulares**

	Ø3.30	Ø3.80	Ø4.25
Antirrotatori	H 0.5 mm AU17-330600-05	AU17-380600-05	AU17-420600-05
Rotatorio	H 0.5 mm AU17-330650-05	AU17-380650-05	AU17-420650-05



Cargol no inclòs a l'envàs

Rèplica Digital

	Ø3.30	Ø3.80	Ø4.25
	AU17-330010	AU17-380010	AU17-420010

**Scanbody**

	Ø3.30	Ø3.80	Ø4.25
	AU17-332201	AU17-382201	AU17-422201



Cargol no inclòs a l'envàs



Zimmer® Screw Vent®

Plataformes:

XN Ø2.90 / NP Ø3.50 / RP Ø4.50 / WP Ø5.70

Connexió Cargol Clínic:

Hexagonal 1.27

Compatible amb:

Zimmer Dental® Tapered Screw-Vent® / BioHorizons® Tapered Internal, Internal Plus, Tapered Tissue Level i altres.

Pilar Cicatrització Torque màx: 20 Ncm



	Ø2.90	Ø3.50				Ø4.50		Ø5.70
Perfil Emergència	Ø3.70	Ø3.50	Ø4.50	Ø4.80	Ø5.50	Ø4.50	Ø5.50	Ø6.50
H 1.5 mm	AU49-292115-D37	-	-	-	-	-	-	-
H 2.0 mm	-	AU49-302120	AU49-302120-D45	-	AU49-302120-D55	-	-	-
H 3.0 mm	AU49-292130-D37	AU49-302130	AU49-302130-D45	AU49-302130-D48	AU49-302130-D55	AU49-402130	AU49-402130-D55	AU49-502130
H 4.0 mm	-	AU49-302140	AU49-302140-D45	-	-	AU49-402140	AU49-402140-D55	-
H 4.5 mm	AU49-292145-D37	-	-	-	-	-	-	-
H 5.0 mm	-	AU49-302150	AU49-302150-D45	AU49-302150-D48	AU49-302150-D55	AU49-402150	AU49-402150-D55	AU49-502150
H 7.0 mm	-	AU49-302170	AU49-302170-D45	AU49-302170-D48	AU49-302170-D55	-	-	-

Coping Impressió



	Ø2.90	Ø3.50	Ø4.50	Ø5.70
C. Abierta	AU49-290090	AU49-300090	AU49-400090	AU49-500090
C. Cerrada	-	AU49-300080	-	-



Rèplica



	Ø2.90	Ø3.50	Ø4.50	Ø5.70
	AU49-290015	AU49-300015	AU49-400015	AU49-500015



Cargol Clínic Torque màx:25 Ncm



	Ø2.90	Ø3.50	Ø4.50	Ø5.70
Hex. 1.27	M1.6	1-72 UNF (Ø 1.8MM)		
Normal	AU49-290056	AU49-E30056	AU49-E30056	AU49-E30056
DLC	-	AU49-E30056-N	AU49-E30056-N	AU49-E30056-N



Veure eines a la pàgina 48

Calcinable amb Base Cr-Co



	Ø2.90	Ø3.50	Ø4.50	Ø5.70
Antirotatori	AU49-290400	AU49-300400	AU49-400400	AU49-500400
Rotatori	-	AU49-300450	AU49-400450	-



Cargol no inclòs a l'envàs

Pilar Provisional



	Ø2.90	Ø3.50	Ø4.50
Antirotatori	AU49-290300	AU49-300300	AU49-400300
Rotatori	-	AU49-300350	AU49-400350



Cargol no inclòs a l'envàs

Calcinable (POM C)



	Ø2.90	Ø3.50	Ø4.50	Ø5.70
Antirotatori	AU49-290200	AU49-300200-A	AU49-400200	AU49-500200
Rotatori	-	AU49-300250-A	AU49-400250	AU49-500250



Cargol no inclòs a l'envàs

Pilar Cimentable Recte Antirrotatori



	Ø3.50	Ø4.50	Ø5.70
H 0.0 mm	AU49-301320	AU49-401320	-
H 1.0 mm	AU49-301321	AU49-401321	-
H 2.0 mm	AU49-301322	AU49-401322	-
H 3.0 mm	AU49-301323	AU49-401323	-



Cargol no inclòs a l'envàs

Pilar Cimentable Angulat Antirrotatori



	Ø3.50	Ø4.50	Ø5.70
15°	H 1.0 mm	AU49-301515-1	-
	H 2.0 mm	AU49-301515-2	-
	H 3.0 mm	AU49-301515-3	-
25°	H 1.0 mm	AU49-301525-1	-
	H 2.0 mm	AU49-301525-2	-
	H 3.0 mm	AU49-301525-3	-



Cargol no inclòs a l'envàs

Pilar Multi-Use Recte Torque màx: 30 Ncm



	Ø3.50	Ø4.50	Ø5.70
H 1.0 mm	AU49-301010	AU49-401010	-
H 2.0 mm	AU49-301020	AU49-401020	-
H 3.0 mm	AU49-301030	AU49-401030	-
H 4.0 mm	AU49-301040	AU49-401040	-
H 5.0 mm	AU49-301050	AU49-401050	-



Vegeu components Multi-Use a la pàgina 46

Pilar Multi-Use Angulat Torque màx: 30 Ncm



	Ø3.50	Ø4.50
17°	H 2.0 mm	AU49-301217
	H 3.0 mm	AU49-301217-3
	H 4.0 mm	AU49-301217-4
30°	H 4.0 mm	AU49-301230
	H 5.0 mm	AU49-301230-5
	H 6.0 mm	AU49-301230-6



Vegeu components Multi-Use a la pàgina 46

Pilar Elitor Recte Torque màx: 30 Ncm



	Ø2.90	Ø3.50	Ø4.50	Ø5.70
H 0.0 mm	-	AU65-PA350	AU65-PA450	-
H 1.0 mm	AU65-PA291	AU65-PA351	AU65-PA451	AU65-PA501
H 2.0 mm	AU65-PA292	AU65-PA352	AU65-PA452	AU65-PA502
H 3.0 mm	AU65-PA293	AU65-PA353	AU65-PA453	AU65-PA503
H 4.0 mm	AU65-PA294	AU65-PA354	AU65-PA454	AU65-PA504
H 5.0 mm	AU65-PA295	AU65-PA355	AU65-PA455	AU65-PA505
H 6.0 mm	AU65-PA296	AU65-PA356	AU65-PA456	-



Vegeu components Elitor a la pàgina 47

Pilar Elitor Angulat Torque màx: 30 Ncm



	Ø3.50
15°	H 1.5 mm
	H 3.0 mm



Vegeu components Elitor a la pàgina 47

Base Cr-Co Angularable



	Ø3.50	Ø4.50
Antirrotatori	AU49-300410	AU49-400410
Rotatori	AU49-300460	AU49-400460



Cargol no inclòs a l'envàs

Cargol Clínic Angularable Torque màx: 25 Ncm



Connexió	Ø3.50	Ø4.50
Tetralobular	AU49-E30050	AU49-E30050
Angled Grip®	AU49-E30060	AU49-E30060



Veure eines a la pàgina 48

Xemeneia Calcinable Angularada



	Ø3.50	Ø4.50
17°	AU67-001701	AU67-001701
30°	AU67-003001	AU67-003001



Interfases Angulables



	Ø3.50	Ø4.50
Antirrotator	H 0.5 mm	AU49-300600-05
	H 1.5 mm	AU49-300600-15
	H 3.0 mm	AU49-300600-30
Rotatori	H 0.5 mm	AU49-300650-05
	H 1.5 mm	AU49-300650-15
	H 3.0 mm	AU49-300650-30



Cargol no inclòs a l'envàs

Scanbody



Ø3.50	Ø4.50	Ø5.70
AU49-302201	AU49-402201	-

Cargol no inclòs a l'envàs



Rèplica Digital



Ø3.50	Ø4.50	Ø5.70
AU49-300010	AU49-400010	-



Components Multi-Use

Plataforma:

RP Ø4.8 / WP Ø6.5

Connexió Cargol Clínic:

UNIGRIP® / Hexagonal 1.27

Compatible amb:

Nobel Biocare®, Multi-Use.

Coping d'Impressió



Rèplica



Tap Cicatrització Titani



RP Ø4.8		
C. Oberta	Unigrip	AU43-500090
	Hexagonal 1.27	AU43-5000190
C. Tancada		AU43-500080



RP Ø4.8	WP Ø6.5
AU43-500015	AU43-600015



	RP Ø4.8	WP Ø6.5
Hexagonal 1.27	AU43-000007	-
Unigrip	AU43-000006	-



Tornillo Clínic Torque màx: 25 Ncm



Pilar Provisional



	RP Ø4.80	WP Ø6.50
UNIGRIP	Métrica	M1.4
	Normal	AU43-E50057
	DLC	AU43-E50057-N
HEXAGONAL 1.27	Normal	AU43-E50056
	DLC	AU43-500056-N



	RP Ø4.8	WP Ø6.5
Titani Rotatori	AU43-500300	AU43-600300
Peek Rotatori	AU43-500500	-



Veure eines a la pàgina 48

Lorem ipsum

Calcinable (POM C)



Calcinable amb base Cr-Co



	RP Ø4.80	WP Ø6.50
Antirrotatori	-	-
Rotatori	AU43-500250	AU43-600250



	RP Ø4.80	WP Ø6.50
Antirrotatori	-	-
Rotatori	AU43-500450	-



Cargol no inclòs a l'envàs

Cargol no inclòs a l'envàs

Cargol Clínic Ang. Torque màx: 25 Ncm



Pilar Elitor Torque màx: 30 Ncm



Base Cr-Co Angularable



	RP Ø4.80
	M1.4
Tetralobular	AU43-E50050
Angled Grip®	AU43-500060



RP Ø4.80
AU43-654800



	RP Ø4.80
Antirrotatori	-
Rotatori	AU43-500460



Veure eines a la pàgina 48

Veure Components Elitor a la pàgina -47

Veure eines a la pàgina 48

Interfases Angularables



Rèplica Digital



Scanbody



	RN Ø4.80
Rotatori	H 0.5 mm
	AU43-500650-05



RP Ø4.8
AU43-500010



RP Ø4.8
AU43-502201



Cargol no inclòs a l'envàs

Cargol no inclòs a l'envàs

Componentes Sobredentadura Elitor

Compatible amb:

Compatible amb: Locatoř / Kerator[®] / Elitor[®] i altres



Pilar Elitor Barra



AU65-00BAR



Insert Calcinable Roscat



AU65-016



Transportador



AU65-011



Coping d'Impressió



AU65-012



Rèplica



AU65-010



Volandera Espaiadora (Pack 4 unit)



AU65-006/4



**Retenidors
(Pack 4 uds)**



Negre	AU65-000/4
Vermell	AU65-001/4 (1.0 lbs)
Blau	AU65-002/4 (1.5 lbs)
Tronja	AU65-005/4 (2.0 lbs)
Rosa	AU65-003/4 (3.0 lbs)
Verd	AU65-007/4 (4.0 lbs)
Transparent	AU65-004/4 (5.0 lbs)



**Kit de
Processat**



Càpsula metàl·lica + 5 Retenidors
+ Volandera espaiadora
AU65-009KIT



**Kit de Processat
Angulat**



Càpsula metàl·lica + 4 Retenidors
+ Volandera espaiadora
AU65-009KITANG



**Eina Multifunció
per Elitor**



VDVL-3



**Càpsula Metàl·lica
+ Retenció Negra (Pack 4 unit)**



AU65-009/4

















Claus i Eines

Claus Protèsiques



								
	Hexagonal 0.90	Hexagonal 1.0	Hexagonal 1.20	Hexagonal 1.25	Hexagonal 1.27	Hexagonal 1.30	Torx	Unigrip
Manual								
Curta (22mm)	AU59-200090-S	AU59-200105	AU59-200130	AU59-200120	AU59-200127-S	AU59-200115	AU59-200173	AU59-200177
Llarga (29mm)	AU59-200090-L	AU59-200100	AU59-200135	AU59-200125	AU59-200127-L	AU59-200110	AU59-200174	AU59-200178

				
	Hexagonal 1.20	Hexagonal 1.25	Hexagonal 1.27	Unigrip
Carraca Connexió 4x4				
Curta (17mm)	AU59-100130	AU59-100120	AU59-100140	AU59-100150
Llarga (21mm)	AU59-100135	AU59-100125	AU59-100145	AU59-100155

											
	Hexagonal 0.90	Hexagonal 1.0	Hexagonal 1.20	Hexagonal 1.25	Hexagonal 1.27	Hexagonal 1.30	Hexagonal 1.70	Torx	Unigrip	Neo	Quadrada 1.30
Contra-angle											
Curta (20mm)	AU58-100205-S	AU58-100111	AU58-100130	AU58-100120	AU58-100117	AU58-100132	AU58-100185	AU58-100174	AU58-100178	AU58-100179	AU58-100133
Llarga (25mm)	AU58-100205	AU58-100111-M	AU58-100135	AU58-100125	AU58-100118	AU58-100132-M	AU58-100186	AU58-100174-M	AU58-100178-M	AU58-100179-M	AU58-100133-M
X Llarga (35mm)	-	-	AU58-100135-L	AU58-100125-L	AU58-100118-L	-	-	AU58-100174-L	AU58-100178-L	-	-









		
	Hexagonal 1.27	Unigrip
Manual/Carraca Ø 7.0mm		
Curta (22mm)	AU59-200127-S-R	AU59-200177-R
Llarga (29mm)	AU59-200127-L-R	AU59-200178-R



Claus i Eines

Claus Per a Pilars Transeptuals



			
	Multi-Use Hex.2.0	Multi-Use Hex.2.5	Elitor
Manual			
Curta (22mm)	AU59-200160-S	AU59-200161-S	-
Llarga (29mm)	AU59-200160-L	AU59-200161-L	-
			
	Multi-Use Hex.2.0	Multi-Use Hex.2.5	Elitor
Carraca			
Curta (17mm)	AU59-100160	AU59-100161	AU59-100146
Llarga (21mm)	AU59-100160-L	AU59-100161-L	-
			
	Multi-Use Hex.2.0	Multi-Use Hex.2.5	Elitor
Contra-ANGLE			
Uorta (20mm)	AU58-100160	AU58-100161	AU58-100146

Claus Per a Cargols Angulables



		
	Angled Grip	Tetralobular
Contra-angle		
Curta (20mm)	AU58-100300	AU58-400100-S
Llarga (25mm)	AU58-100300-M	AU58-400200-L
X Llarga (35mm)	-	AU58-400300-EL

Claus Per a Cargols d'Osteosintesi



	
	Multi-Use Hex.2.0
Contra-angle	
Llarga (25mm)	AU58-200100-L

Carraques Dinamomètriques



VDIN

QUADRADA 4*4



VDIN2

CONNEXIÓ Ø7.0



Kits Protèssics



Contra-angle			
Curta	(20mm)	Esteritzable	AU58-100001
Llarg	(25mm)	Esteritzable	AU58-100002





Claus i Eines

Mànecs i Adaptadors



**Adaptador de
Contra-Angle a Carraca**



Straumann Ø7	AU59-100198
Nobel Biocare Ø8	AU59-100199



**Mànec per clau
Contra-Angle**



Curt	AU58-100190
Llarg	AU58-100190-LP



**Adaptador de Contra-Angleo a
Carraca Quadrada 4x4mm**



AU59-100194

Kit d'Extractors Implants i Cargols Coronats



Kit d'Extractors No 1, 2, 3, 4 (inclou Adaptador + Extensor + Caixa)



AU EXT-IMP KIT-2



**Extractor Cargol Coronat N.1
per Carraca Quadrada 4x4mm**



AU EXT-IMP-1



**Extractor Cargol Coronat N.2
per Carraca Quadrada 4x4mm**



AU EXT-IMP-2



**Adaptador Clau Carraca Quadrada
4x4mm**

AU59-100191



Per a implants M 1.6.
Torque màxim 100 Ncm

**Extractor Cargol Coronat N.3
per Carraca Quadrada 4x4mm**



AU EXT-IMP-3



Per implants M 1.8 - M 2.
Torque màxim 200 Ncm

**Extractor Cargol Coronat N.4 per
Carraca Quadrada 4x4mm**



AU EXT-IMP-4



**Extensor per Carraca
Quadrada 4x4mm**



AU59-100195

Altres Connexions Disponibles

Hexàgon Extern Alt

Compatible amb:

Compatible amb: Klocknef.

Coping d'Impressió

AU10-000090



Rèplica

AU10-000015



Cargol

AU10-000052



Calcinable (POM C)

Antirrotatori AU10-000200

Rotatori AU10-000250



Pilar Elitor

H 2.0 mm AU65-KL422

H 3.0 mm AU65-KL423

H 4.0 mm AU65-KL424



Hexàgon Extern TSH2

Compatible amb:

Phibo® TSH2.

Pilar Elitor Recte

H 1.0 mm AU65-TSH331

H 2.0 mm AU65-TSH332

H 3.0 mm AU65-TSH333

H 4.0 mm AU65-TSH334

H 5.0 mm AU65-TSH335



MIS C1

Compatible amb:

Compatible amb MIS C1

Pilar Elitor Recte

SP Ø4.2

H 1.0 mm AU65-MC421

H 2.0 mm AU65-MC422

H 3.0 mm AU65-MC423

H 4.0 mm AU65-MC424

H 5.0 mm AU65-MC425

H 6.0 mm AU65-MC426



Cigomàtic

(Hexàgon extern universal)

Pilar Multi-Use Recte

H 1.0 mm AU43-Z01010

H 2.0 mm AU43-Z01020



Pilar Multi-Use Angulat

H 2.0 mm AU43-501217-2

17° **H 3.0 mm** AU43-501217-3

H 4.0 mm AU43-501217-4

H 3.0 mm AU43-501230-3

30° **H 4.0 mm** AU43-501230-4

H 5.0 mm AU43-501230-5



Cargol Clinic Cigomàtic

Mètrica M2

Normal AU43-501200-Z



Biomateriales

ETGRAFT TCP FOSFAT TRICÀLCICO, 1GR. (FIN O MITJÀ)

Biomaterial sintètic porós a base de fosfat tricàlcic (B-TCP), desenvolupat per a la regeneració òssia.

Composició:

99.9% Fosfato Tricàlcic (B-TCP).

Referència	Geometria	Dimensions	Quantitat
TGR050110P-U	Grànuls	0.5 - 1.0mm	1gr x 1 Unid.
TGR050110P	Grànuls	0.5 - 1.0mm	1gr x 5 Unid.



Distribuidor;



www.eliteabutments.com

info@eliteabutments.com

 **Titanimplant, S.L.**
www.titanimplant.net

C/ General Manso, 28-38, Local 4
08980 Sant Feliu de Llobregat
Barcelona, España.

